

# SONY



## TRIMASTER EL 4K

## Professional Video Monitors

### OLED Monitor Line up

- 4K Master Monitor : BVM-X300
- Master Monitor : BVM-E251/E171
- Picture Monitor : PVM-X550/A250/A170

### LCD Monitor Line up

- Picture Monitor : LMD-A240/A220/A170/941W
- Basic Picture Monitor : LMD-B240/B170/2110W

# Professional Monitor Lineup

OLED

## 4K Master Monitor



BVM-X300

## Master Monitor



BVM-E251



BVM-E171

## Picture Monitor



PVM-X550



PVM-A250



PVM-A170

OLED  
4K Master  
monitor

OLED  
Master  
monitor

OLED  
Picture  
monitor

LCD

## Picture Monitor



LMD-A240



LMD-A220



LMD-A170



LMD-941W

LCD  
Picture  
monitor

## Basic Picture Monitor



LMD-B240



LMD-B170



LMD-2110W

LCD  
Basic  
Picture  
monitor

# Sony TRIMASTER EL fully unleash the potential of OLED

## UNRIVALLED BLACK REPRODUCTION

### Deeper, truer blacks

Solution produces truer blacks, assuring you of a highly precise black level even when viewing under low ambient light.

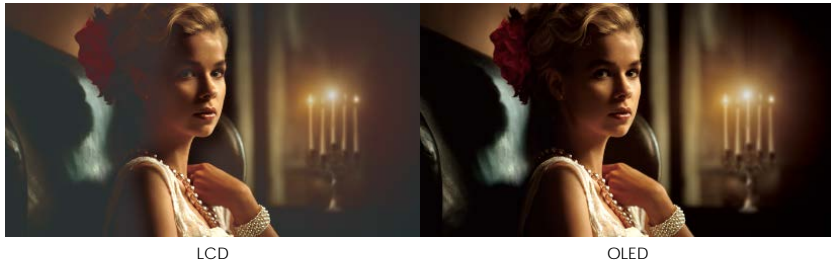

## WIDE DYNAMIC RANGE

### Exceptional dynamic range

Thanks to its wide dynamic range, solution faithfully reproduces a camera's dynamic range for smooth, beautifully detailed gradations.

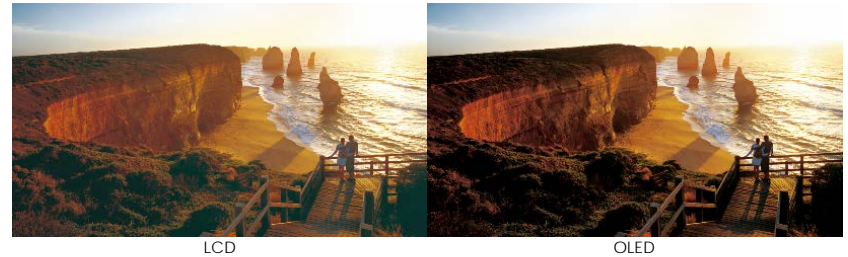

## ACCURATE COLOR REPRODUCTION

### Richer colors in dark areas

By accurately reproducing colors in the low-luminance range, solution allows you to increase image quality by fine-tuning colors in dark areas.

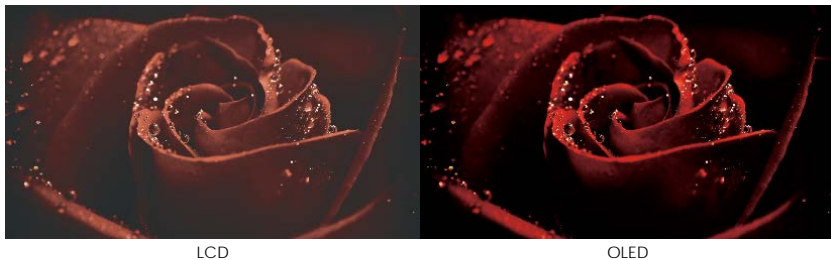

## FAST RESPONSE TIME

### Vastly improved motion depiction

Solution realises outstanding motion response, eliminating blur that hampers focusing on moving subjects.

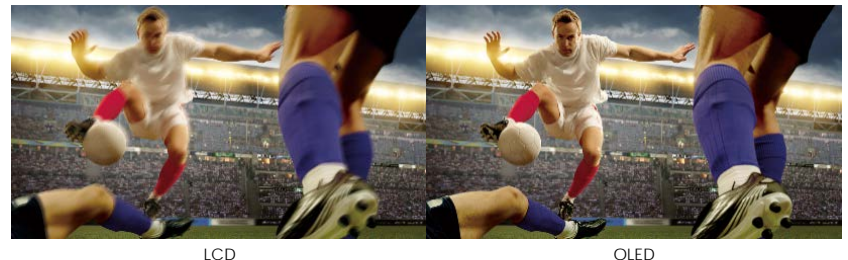

# Unique OLED Technology



## OLED panel

- Accurate Black Reproduction
- Accurate Color Reproduction
- Wide Dynamic Range
- Fast Response Time

## Original OLED processor

- Designed specifically for OLED panel
- Designed specifically to optimise OLED performance
- Accurate gamma control of extreme black details

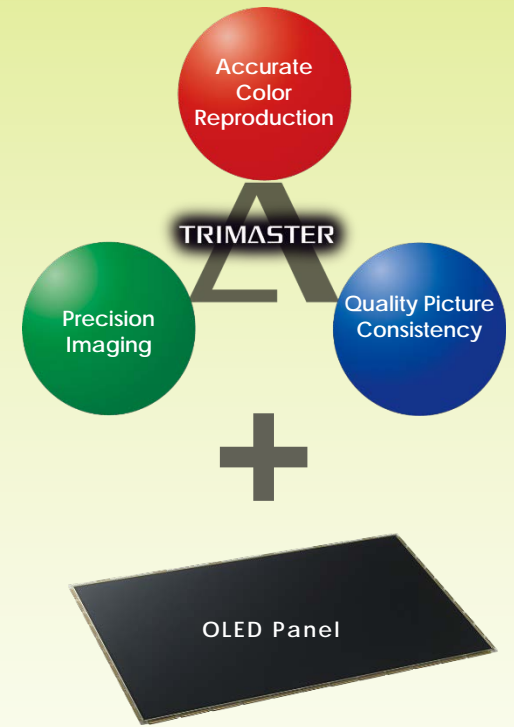

## TRIMASTER EL

TRIMASTER™ Technology is a design architecture used to elicit the full performance capabilities of Professional flat-panel displays. It comprises the core technologies that enable the highest level of color accuracy, precision imaging, and picture-quality consistency.

EL (Electro-Luminescence) is an ideal self-emission display device with a wide dynamic range and high picture quality. By refining TRIMASTER technology with the new EL device, Sony effectively boosts the performance expectations of the professional industry.

## Unrivalled Black Reproduction



### The satisfaction of seeing truer blacks

TRIMASTER EL superbly reproduces deep, truer blacks, allowing you to pick out subtle details and delicate highlights in surrounding areas. This amazing ability to express accurately and clearly tonal differences in extreme low-luminance areas even exceeds older reference CRTs. TRIMASTER EL technology is your assurance of precise image reproduction.

- Because TRIMASTER EL technology accurately displays noise and details in dark areas, aperture and exposure can be finely adjusted, helping to avoid unwanted image artifacts.
- Video engineers can concentrate on adjusting tone and color because it is easier to check the black signal level.

Shooting night scenes is now far easier and delicate differences in dark areas can be faithfully expressed.

### Comparison with conventional technology

A key advantage of TRIMASTER EL technology is the fact that because of its self-emitting properties, each pixel can be turned completely off. No other display technology is able to offer this. Solution is capable of reproducing accurate black with each individual pixel, enabling users to evaluate each picture image faithfully.

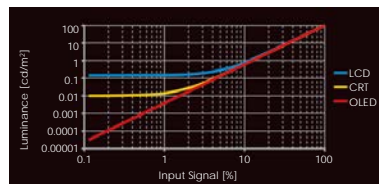

Grey scale images corresponding to the input signal

\* Grey scales are simulated images.

## Accurate Color Reproduction



### The right color regardless of brightness

Reproducing the delicate shades of dark colors is a challenge for any monitor, but which TRIMASTER EL performs with ease. The wide color gamut generated by this technology assures faithful and consistent reproduction of colors over the entire luminance range — an impossible feat in the past for non-OLED monitors. This is critical when:

- Adjusting tone and color during the color grading process.
- Reproducing accurate and deep color when working with CG for animation and games.
- Reproducing the wide color gamut of digital cinema.

Because colors in dark areas can be precisely viewed, TRIMASTER EL is the ideal choice for producing high-quality images.

### Comparison with conventional technology

Technology not only offers a wide color gamut with its accuracy for each of the three primary colors, but also maintains this wide color gamut throughout the entire luminance range.

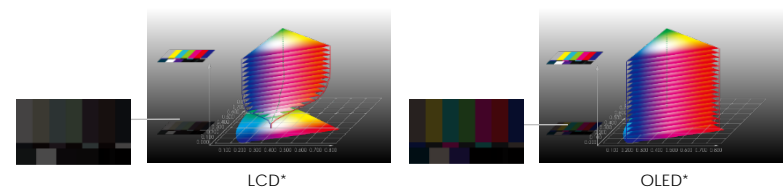

\* color gamut images based on Sony's test results.



## Wide Dynamic Range



### The breathtaking drama of wide dynamic range images

Thanks to the wide dynamic range capability of TRIMASTER EL, you can see every detail that the latest cameras capture. The results are nothing short of stunning, with colors smoothly displayed over the entire tonal range and details clearly reproduced in deep shadows and bright highlights.

- Scenes with challenging lighting conditions can be easily and faithfully reproduced, including delicate metal textures and backlit subjects.
- Because details in dark shadows can be accurately checked, retakes can be reduced.
- Black and peak white colors can be checked more efficiently. In addition, clearer display of subjects reduces eye fatigue.

TRIMASTER EL increases production efficiency, and allows users to create superb high-contrast images and video content for future proofing.

### Comparison with conventional technology

OLED technology has the ability to control each individual pixel from an absolute black to peak white. Each pixel can display the entire dynamic range of the image with no interference to the adjacent pixels.

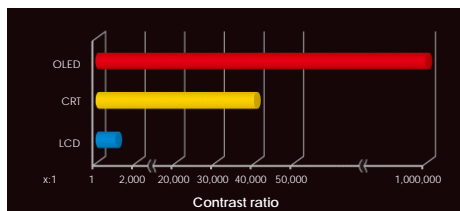

## Fast Response Time



### The overwhelming advantage of virtually blur-free motion

During fast-moving sporting events, balls and players move quickly and often unpredictably — action that can cause blurring with other display technologies. TRIMASTER EL avoids this thanks to a lighting-quick grey-to-grey switching speed that allows faithful monitoring without afterimage. This results in easy tracking and clearly displayed player numbers.

- Fast switching speeds provide clearer panning.
- View moving text clearly with virtually no motion blur.
- Adjust focus on a larger monitor rather than on the camera's viewfinder.

The high image quality of fast-moving subjects increases flexibility when broadcasting sports, allowing production staff to capture the real action of the event and greatly reduce eye fatigue.

### Comparison with conventional technology

Because the OLED emitting layer inherently responds to any electrical current input, it emits light immediately. OLED grey-to-grey switching speed (measured in microseconds,  $\mu$ s) is much faster than that of LCDs (measured in milliseconds, ms).\*

\* Sony test results

#### Grey-to-grey pixel response

Taller bars represent slower switching times, while smaller bars indicate faster switching speeds, resulting in less motion blur.

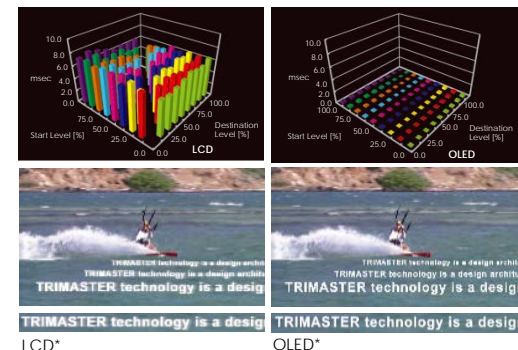

\* Simulated images

# TRIMASTER EL

Unique Super Top Emission technology Deep black with wide dynamic range Quick response with virtually no motion blur Wide color gamut and accurate color reproduction

## TRIMASTER EL – Self-emitting Display Device

TRIMASTER EL creates light by recombining an electron and a hole within certain organic materials. The process of emitting light is extremely efficient when compared to other technologies currently used for display.

Its organic materials react to the control of the electrical current immediately, and do not emit light in the absence of an electrical current. In this way, the OLED display panel features superb black performance and quick response to fast-motion pictures. In addition, OLED display panel delivers a wider color gamut.

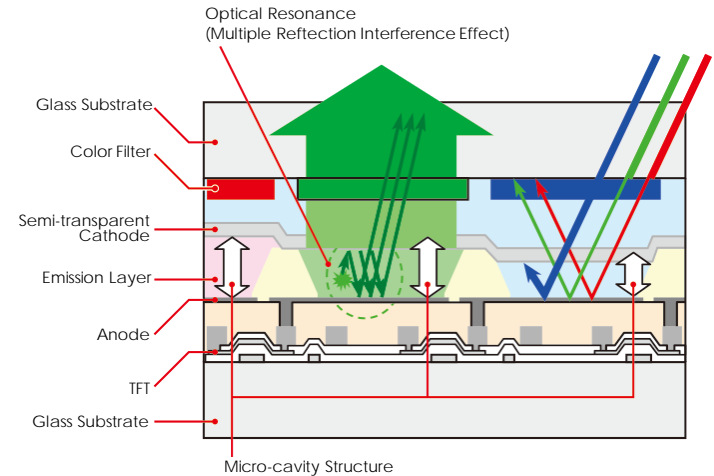

## Super Top Emission Technology

Super Top Emission OLED panel is designed to deliver light emission with the TFT layer on the rear side of the panel. Therefore, the top emission structure offers more efficient light emission than is typical with bottom emission structures where TFT layers are placed on the front side of the panel, limiting the light-emission aperture.

This Super Top Emission technology has a micro-cavity structure which incorporates color filters. This cavity structure uses an optical resonance effect to enhance color purity and improve light-emission efficiency. In addition, the color filter of each RGB also enhances the color purity of emitted light, and reduces ambient light reflection.

Super Top Emission OLED panel is completely sealed by a glass substrate, and the electroluminescent layer is fully isolated from outside air and moisture. This contributes to stability and reliability.

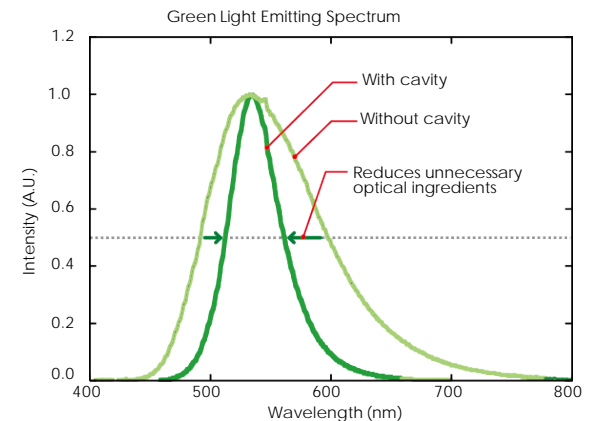

# TRIMASTER EL

Accurate signal processing across all signal levels  
Accurate gamma control  
Superb uniformity control

## Dedicated TRIMASTER EL Processor

The BVM-E, BVM-F, and PVM Series of OLED monitors incorporate OLED-dedicated signal processors to elicit and maximize OLED panel performance. This technology allows these TRIMASTER EL monitors to provide the level of performance required for critical imaging. These processors accurately control gamma and uniformity, and deliver precision stability control.



## Accurate gamma control

Since TRIMASTER EL panel can display a deeper black than any other display device, the TRIMASTER EL processor controls gamma accuracy (black reproduction) by increased signal processing bit depth.

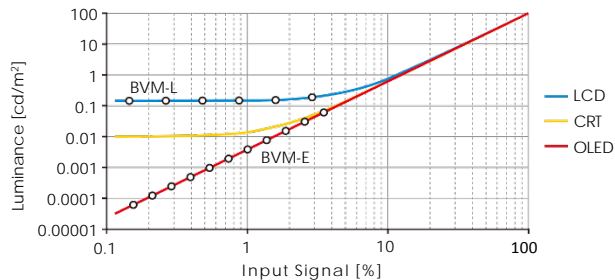

## Superb uniformity control

TRIMASTER EL processor offers superb uniformity across all signal levels at every point of the screen. At the factory, OLED-panel uniformity is precisely measured and corrected using a proprietary RGB LUT (look-up table) adjustment system.

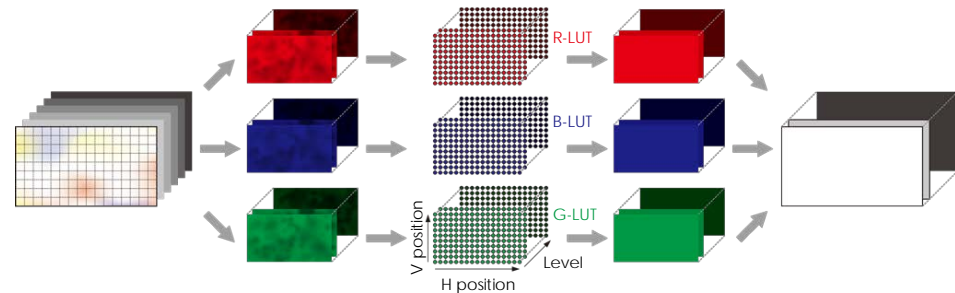



# TRIMASTER EL

## Precision Imaging without Artifact

TRIMASTER EL monitors\* incorporate the motion adaptive I/P conversion method, which detects information from multiple present and past fields. This is superior to conventional technology, which generally uses motion detection in fewer fields.

With this technology, TRIMASTER EL monitors reproduce video signals accurately without artifacts. You'll appreciate the difference immediately – for example, when there's zero tolerance for failure in shooting, you can be confident of fine patterns or delicate commercial logos.

\* BVM-E / BVM-F only.

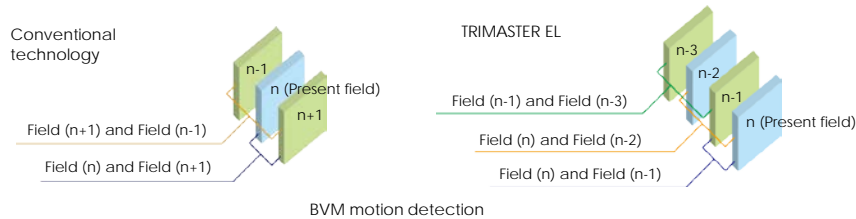

## Consistency/Repeatability

The performance of every TRIMASTER EL monitor is precisely adjusted and inspected on gamma, white balance, uniformity, etc., by a highly-robotized system and by professionally trained human eye at the final stage of manufacture prior to shipping. This quality control process provides substantial consistency and uniformity among TRIMASTER EL monitors.

In addition, color reproduction of BVM monitor can easily and accurately be duplicated to other BVM monitors using the Memory Stick™ copy function. Color reproduction of every monitor is matched to the extreme, regardless of their location.



## Stability

TRIMASTER EL monitors are designed to control pixel-by-pixel light emission of the OLED panel. This system ensures emission stability over a long duration. You can use TRIMASTER monitors continuously over time with confidence.

In addition, Super Top Emission OLED panel is completely sealed by a glass substrate, and the electroluminescent layer is fully isolated from outside air and moisture. This also contributes to stability and reliability. TRIMASTER EL monitors can offer higher performance in terms of luminance and white balance than typical reference monitors.

### Conventional technology



### TRIMASTER EL



\* Simulated image

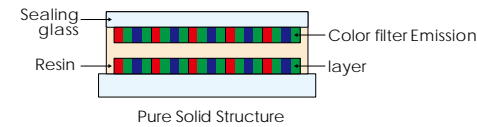
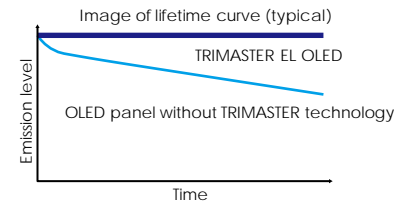

Monitors adjustment / inspection



# BVM-X300

4K OLED Master Monitor



30" 4K OLED Reference Monitor  
For Color Critical, Quality Control  
Operation of HDR/SDR 4K&HD  
production

## Main Features

- BVM Grade OLED Panel
- Full 4K 4096 x 2160 Pixel Resolution
- Accurate black and color reproduction
- Extremely wide viewing angle
- Supports DCI P3 and ITU-R BT.2020 wide color spaces\*1
- Gamut Marker (ITU-R BT.2020 colors outside 709 or DCI-P3)
- Auto White Adjustment
- Quick Response
- High Dynamic Range (S-Log 3, S-Log 3(Live HDR)\*2, ITU-R BT.2100(HLG)\*3, SMPTE ST.2084)
- Sony S-Log Gamma Support
- Multi-format capability
- New Input Setting recall(Input, Color and Luminance setting)\*4
- Flexible Marker\*4 and Area & Aspect Marker
- Versatile 4K/QFHD Input Capability
- 3G-SDI Quad-link up to 4096 x 2160/48p 50p 60p, YCbCr 4:2:2 10-bit
- HD-SDI Dual-link and 4K/2K XYZ signals
- Faster access to the status menu page\*2
- Relative Contrast 1/2, 1/3, 1/4\*2
- HDMI\*2 •Flicker free mode •Interface mode
- Time code display\*4 •Power-on Setting •User Presets
- Password Lock for User Preset •Key Inhibit
- User-friendly Built-in Control Panel
- BKM-16R and BKM-17R control

Picture Performance	
Panel	OLED panel
Picture size (diagonal)	750.2 mm (29 1/2 inches)
Effective Picture size (H x V)	663.6 x 349.9 mm (26 1/4 x 13 7/8 inches)
Resolution (H x V)	4096 x 2160 pixels
Aspect	17 : 9 (1.89 : 1)
Pixel efficiency	99.99%
Panel drive	10-bit
Panel frame rate	48 Hz / 50 Hz / 60 Hz (48 Hz and 60 Hz are also compatible with 1/1.001 frame rates)
Viewing angle (panel specification)	89°/89°/89°/89° (typical) (up/down/left/right contrast > 10:1)
Color temperature	D55, D61, D65, D93, DCI*5, and user 1-5 (5,000 K to 10,000 K adjustable), DCI XYZ
Standard luminance	100 cd/m <sup>2</sup> (100% white signal input)
Color space (color gamut)	ITU-R BT.2020*1, ITU-R BT.709, EBU, SMPTE-C, DCI-P3, BVM-X300 Native*6, S-GAMUT3, S-GAMUT3.cine
Transmission Matrix	ITU-R BT.2020 (Non-constant luminance is supported), ITU-R BT.709
EOTF	2.2, 2.4, 2.6, CRT, 2.4 (HDR), S-Log3 (HDR), S-Log3 (Live HDR), S-Log2 (HDR), SMPTE ST 2084, RGB(SG 1.2), ITU-BT.2100(SG 1.2)
Input	
SDI (3G/HD)	BNC (x4) Input impedance: 75 ohms unbalanced
HDMI	HDMI(HDCP2.2) (x1)
Serial remote (LAN)	Ethernet (10BASE-T/100BASE-TX), RJ-45 (x1)
Output	
SDI (3G/HD)	BNC (x4), switched out*7 Input impedance: 75 ohms unbalanced
Audio monitor	Stereo mini jack (x1)
Headphones	Stereo mini jack (x1)
General	
Power requirement	AC 100 V to 240 V, 2.8 A to 1.2 A, 50/60 Hz
Power consumption	Approx. 280 W (max.) Approx. 150 W (average power consumption in the default status)
Operating temperature	0°C to 35°C (32°F to 95°F) Recommended: 20°C to 30°C (68°F to 86°F)
Operating humidity	30% to 85% (no condensation)
Storage / transport temperature	-20°C to +60°C (-4°F to +140°F)
Storage / transport humidity	0% to 90%
Operating / storage / transport pressure	700 hPa to 1060 hPa
Dimensions (W x H x D)	742.4 x 479.5 x 205 mm (29 1/4 x 19 x 8 1/8 inches)
Mass	16.2 kg (35 lb 12 oz)
Supplied accessories	AC power cord (1), AC plug holder (1), CD-ROM (1), Before Using This Unit (1), HDMI cable holder (1), European Representative (1)

\*1 The BVM-X300 does not cover the BT.2020 color space in full. \*2 Supported from V.2.0.  
\*3 Changed from V2.1. \*4 Supported from V.2.2. \*5 DCI: x=0.314 y=0.351.  
\*6 The BVM-X300 individual chromaticity points. The widest color space setting of the signal is reproduced by the BVM-X300.  
\*7 The last selected SDI form SDI 1 or SDI 2 input signal are output.

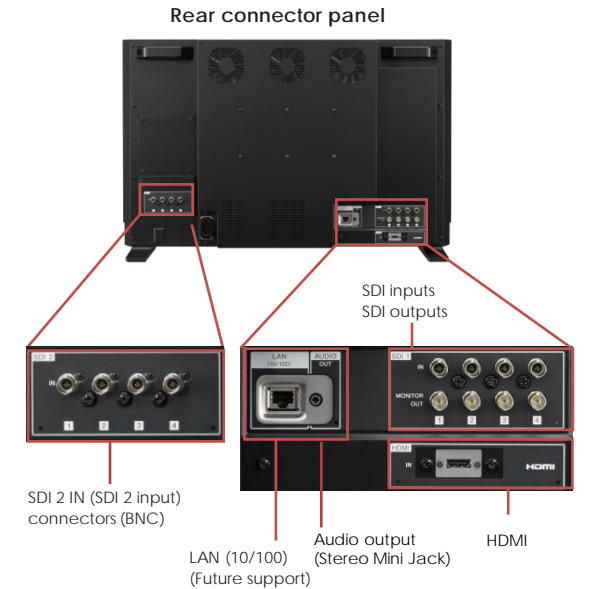

## Dimensions

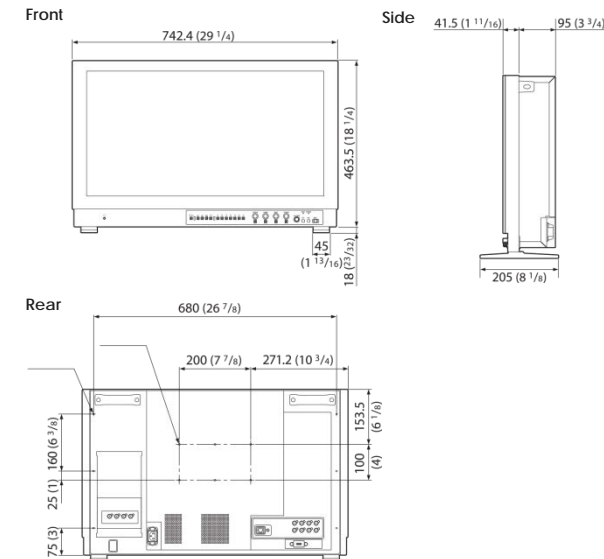

To install on a vehicle, fix the unit using screw holes for the YOKE mount.

Unit: mm(inches)

### Formats

Signal System	Signal Format		
<b>2K/HD (HD-SDI)</b>			
1920 × 1080/60 <sup>*1</sup> , 50i, 30p <sup>*1</sup> , 30PsF <sup>*1</sup> , 25p, 25PsF, 24p <sup>*1</sup> , 24PsF <sup>*1</sup>	4 : 2 : 2 YCbCr	10 bit	
1280 × 720/60p <sup>*1</sup> , 50p, 30p <sup>*1</sup> , 25p, 24p <sup>*1</sup>			
2048 × 1080/30p <sup>*1</sup> , 30PsF <sup>*1</sup> , 25p, 25PsF, 24p <sup>*1</sup> , 24PsF <sup>*1</sup>			
<b>2K/HD (HD-SDI Dual link)</b>			
1920 × 1080/60p <sup>*1</sup> , 50p	4 : 2 : 2 YCbCr	10 bit	
1920 × 1080/60 <sup>*1</sup> , 50i, 30p <sup>*1</sup> , 30PsF <sup>*1</sup> , 25p, 25PsF, 24p <sup>*1</sup> , 24PsF <sup>*1</sup>	4 : 4 : 4 RGB	10 bit / 12 bit	
2048 × 1080/60p <sup>*1</sup> , 50p, 48p <sup>*1</sup>	4 : 4 : 4 YCbCr	10 bit / 12 bit	
2048 × 1080/60p <sup>*1</sup> , 50p, 48p <sup>*1</sup>	4 : 2 : 2 YCbCr	10 bit	
2048 × 1080/30p <sup>*1</sup> , 30PsF <sup>*1</sup> , 25p, 25PsF, 24p <sup>*1</sup> , 24PsF <sup>*1</sup>	4 : 4 : 4 RGB	10 bit / 12 bit	
2048 × 1080/30p <sup>*1</sup> , 30PsF <sup>*1</sup> , 25p, 25PsF, 24p, 24PsF	4 : 4 : 4 YCbCr	10 bit / 12 bit	
<b>2K/HD (3G-SDI)</b>			
1920 × 1080/60p <sup>*1</sup> , 50p	4 : 2 : 2 YCbCr	10 bit	Level A / Level B-DL
1920 × 1080/60 <sup>*1</sup> , 50i, 30PsF <sup>*1</sup> , 25PsF, 24p <sup>*1</sup>	4 : 4 : 4 RGB	10 bit / 12 bit	Level A / Level B-DL
1920 × 1080/60 <sup>*1</sup> , 50i, 30PsF <sup>*1</sup> , 25PsF, 24p <sup>*1</sup>	4 : 4 : 4 YCbCr	10 bit / 12 bit	Level A / Level B-DL
1920 × 1080/30p <sup>*1</sup> , 25p, 24PsF <sup>*1</sup>	4 : 4 : 4 RGB	10 bit / 12 bit	Level A / Level B-DL
1920 × 1080/30p <sup>*1</sup> , 25p, 24PsF <sup>*1</sup>	4 : 4 : 4 YCbCr	10 bit / 12 bit	Level A / Level B-DL
1280 × 720/60p <sup>*1</sup> , 50p, 30p <sup>*1</sup> , 25p, 24p <sup>*1</sup>	4 : 4 : 4 RGB	10 bit	Level A
1280 × 720/60p <sup>*1</sup> , 50p, 30p <sup>*1</sup> , 25p, 24p <sup>*1</sup>	4 : 4 : 4 YCbCr	10 bit	Level A
2048 × 1080/60p <sup>*1</sup> , 50p, 48p <sup>*1</sup>	4 : 2 : 2 YCbCr	10 bit	Level A / Level B-DL
2048 × 1080/30p <sup>*1</sup> , 30PsF <sup>*1</sup> , 25p, 25PsF, 24p <sup>*1</sup> , 24PsF <sup>*1</sup>	4 : 4 : 4 RGB	10 bit / 12 bit	Level A / Level B-DL
2048 × 1080/30p <sup>*1</sup> , 30PsF <sup>*1</sup> , 25p, 25PsF, 24p, 24PsF	4 : 4 : 4 YCbCr	10 bit / 12 bit	Level A / Level B-DL
2048 × 1080/30p, 30PsF, 25p, 25PsF, 24p, 24PsF	4 : 4 : 4 XYZ	12 bit	Level A / Level B-DL
<b>2K/HD (3G-SDI Dual Link)</b>			
1920 × 1080/60p <sup>*1</sup> , 50p	4 : 4 : 4 RGB	10 bit / 12 bit	Level A / Level B-DL
1920 × 1080/60p <sup>*1</sup> , 50p	4 : 4 : 4 YCbCr	10 bit / 12 bit	Level A / Level B-DL
2048 × 1080/60p <sup>*1</sup> , 50p, 48p <sup>*1</sup>	4 : 4 : 4 RGB	10 bit / 12 bit	Level A / Level B-DL
2048 × 1080/60p <sup>*1</sup> , 50p, 48p <sup>*1</sup>	4 : 4 : 4 YCbCr	10 bit / 12 bit	Level A / Level B-DL
<b>4K/UHD (3G-SDI Dual Link)</b>			
3840 × 2160/30p <sup>*1</sup> , 25p, 24p <sup>*1</sup>	4 : 2 : 2 YCbCr	10 bit	Level B-DS <sup>*2</sup>
3840 × 2160/30p <sup>*1</sup> , 25p, 24p <sup>*1</sup>	4 : 2 : 2 YCbCr	10 bit	
3840 × 2160/30PsF <sup>*1</sup> , 25PsF, 24PsF <sup>*1</sup>	4 : 2 : 2 YCbCr	10 bit	Level B-DS <sup>*2</sup>
4096 × 2160/30p <sup>*1</sup> , 25p, 24p <sup>*1</sup>	4 : 2 : 2 YCbCr	10 bit	
4096 × 2160/30PsF <sup>*1</sup> , 25PsF, 24PsF <sup>*1</sup>	4 : 2 : 2 YCbCr	10 bit	Square division
<b>4K/UHD (HD-SDI Quad Link)</b>			
3840 × 2160/30p <sup>*1</sup> , 30PsF <sup>*1</sup> , 25p, 25PsF, 24p <sup>*1</sup> , 24PsF <sup>*1</sup>	4 : 2 : 2 YCbCr	10 bit	Square division
4096 × 2160/30p <sup>*1</sup> , 30PsF <sup>*1</sup> , 25p, 25PsF, 24p <sup>*1</sup> , 24PsF <sup>*1</sup>	4 : 2 : 2 YCbCr	10 bit	Square division
<b>4K/UHD (3G-SDI Quad Link)</b>			
3840 × 2160/60p <sup>*1</sup> , 50p	4 : 2 : 2 YCbCr	10 bit	Level A / Level B-DL
3840 × 2160/60p <sup>*1</sup> , 50p	4 : 4 : 4 RGB	10 bit / 12 bit	Level A / Level B-DL
3840 × 2160/60p <sup>*1</sup> , 50p	4 : 4 : 4 YCbCr	10 bit / 12 bit	Level A / Level B-DL
3840 × 2160/30p <sup>*1</sup> , 25p, 24p <sup>*1</sup>	4 : 4 : 4 RGB	10 bit / 12 bit	Level A / Level B-DL
3840 × 2160/30p <sup>*1</sup> , 25p, 24p <sup>*1</sup>	4 : 4 : 4 YCbCr	10 bit / 12 bit	Level A / Level B-DL
3840 × 2160/30PsF <sup>*1</sup> , 25PsF, 24PsF <sup>*1</sup>	4 : 4 : 4 RGB	10 bit / 12 bit	Level A / Level B-DL
3840 × 2160/30PsF <sup>*1</sup> , 25PsF, 24PsF <sup>*1</sup>	4 : 4 : 4 YCbCr	10 bit / 12 bit	Level A / Level B-DL
4096 × 2160/60p <sup>*1</sup> , 50p, 48p <sup>*1</sup>	4 : 2 : 2 YCbCr	10 bit	Level A / Level B-DL
4096 × 2160/60p <sup>*1</sup> , 50p, 48p <sup>*1</sup>	4 : 4 : 4 RGB	10 bit / 12 bit	Level A / Level B-DL
4096 × 2160/60p <sup>*1</sup> , 50p, 48p <sup>*1</sup>	4 : 4 : 4 YCbCr	10 bit / 12 bit	Level A / Level B-DL
4096 × 2160/30p <sup>*1</sup> , 25p, 24p <sup>*1</sup>	4 : 4 : 4 RGB	10 bit / 12 bit	Level A / Level B-DL
4096 × 2160/30p <sup>*1</sup> , 25p, 24p <sup>*1</sup>	4 : 4 : 4 YCbCr	10 bit / 12 bit	Level A / Level B-DL
4096 × 2160/30PsF <sup>*1</sup> , 25PsF, 24PsF <sup>*1</sup>	4 : 4 : 4 RGB	10 bit / 12 bit	Level A / Level B-DL
4096 × 2160/30PsF <sup>*1</sup> , 25PsF, 24PsF <sup>*1</sup>	4 : 4 : 4 YCbCr	10 bit / 12 bit	Level A / Level B-DL
4096 × 2160/30p, 25p, 24p	4 : 4 : 4 XYZ	12 bit	Level A / Level B-DL
4096 × 2160/30p, 25p, 24p	4 : 4 : 4 XYZ	12 bit	Level A / Level B-DL
4096 × 2160/30PsF, 25PsF, 24PsF	4 : 4 : 4 XYZ	12 bit	Level A / Level B-DL

\*1 Also compatible with 1/1.001.

\*2 When Square is selected (physically same when 2SI is selected).

# BVM-X300

4K OLED Master Monitor

## HDMI

Signal System	Signal Format	Standard
640 × 480/60p*1	4 : 4 : 4 RGB 12 bit / 10 bit / 8 bit	CEA-861-D
	4 : 4 : 4 YCbCr 12 bit	
	4 : 2 : 2 YCbCr 12 bit	
720 × 480/60p*1	4 : 4 : 4 RGB 12 bit / 10 bit / 8 bit	CEA-861-D
	4 : 4 : 4 YCbCr 12 bit	
	4 : 2 : 2 YCbCr 12 bit	
720 × 576/50p	4 : 4 : 4 RGB 12 bit / 10 bit / 8 bit	CEA-861-D
	4 : 4 : 4 YCbCr 12 bit	
	4 : 2 : 2 YCbCr 12 bit	
1280 × 720/60p*1, 50p	4 : 4 : 4 RGB 12 bit / 10 bit / 8 bit	CEA-861-D
	4 : 4 : 4 YCbCr 12 bit	
	4 : 2 : 2 YCbCr 12 bit	
1920 × 1080/60i*1, 50i	4 : 4 : 4 RGB 12 bit / 10 bit / 8 bit	CEA-861-D
	4 : 4 : 4 YCbCr 12 bit	
	4 : 2 : 2 YCbCr 12 bit	
1920 × 1080/60p*1, 50p, 30p*1, 25p, 24p*1	4 : 4 : 4 RGB 12 bit / 10 bit / 8 bit	CEA-861-D
	4 : 4 : 4 YCbCr 12 bit	
	4 : 2 : 2 YCbCr 12 bit	
2048 × 1080/60p*1, 50p, 48p, 30p*1, 25p, 24p*1	4 : 4 : 4 RGB 12 bit / 10 bit / 8 bit	No Standard
	4 : 4 : 4 YCbCr 12 bit	
	4 : 2 : 2 YCbCr 12 bit	
3840 × 2160/60p*1*2, 50p*2	4 : 4 : 4 RGB 8 bit *3	CEA-861-F
	4 : 4 : 4 YCbCr 12 bit*3	
	4 : 2 : 2 YCbCr 8 bit	
	4 : 2 : 0 YCbCr 8 bit	
3840 × 2160/30p*1*2, 25p*2, 24p*1*2	4 : 4 : 4 RGB 12 bit / 10 bit / 8 bit*3*5	CEA-861-F
	4 : 4 : 4 YCbCr 12 bit / 10 bit / 8 bit*3*4	
	4 : 2 : 2 YCbCr 12 bit	
	4 : 2 : 0 YCbCr 8 bit	
4096 × 2160/60p*1*2, 50p*2	4 : 4 : 4 RGB 8 bit *3	CEA-861-F
	4 : 4 : 4 YCbCr 12 bit*3	
	4 : 2 : 2 YCbCr 12 bit*3	
	4 : 2 : 0 YCbCr 8 bit	
4096 × 2160/30p*1*2, 25p*2, 24p*1*2	4 : 4 : 4 RGB 12 bit / 10 bit / 8 bit*3*5	CEA-861-F
	4 : 4 : 4 YCbCr 12 bit / 10 bit / 8 bit*3*4	
	4 : 2 : 2 YCbCr 12 bit	
	4 : 2 : 0 YCbCr 8 bit	
800 × 600/60p	4 : 4 : 4 RGB 12 bit / 10 bit / 8 bit	VESA and Industry Standards and Guidelines for Computer Display Monitor Timing(DMT)
	4 : 4 : 4 YCbCr 12 bit	
	4 : 2 : 2 YCbCr 12 bit	
1024 × 768/60p	4 : 4 : 4 RGB 12 bit / 10 bit / 8 bit	VESA and Industry Standards and Guidelines for Computer Display Monitor Timing(DMT)
	4 : 4 : 4 YCbCr 12 bit	
	4 : 2 : 2 YCbCr 12 bit	

\*1 Also compatible with the frame rate 1/1.001.

\*2 This signal is described as "equivalent to the 4K signal" in this manual.

\*3 [Enhanced Format] must be selected in the [HDMI Signal Format] menu. Also, when using this input signal, use the Premium High-Speed HDMI cable. (30P, 25P, 24P signals are only for the 4:4:4 RGB/YCbCr 10/12bit signal.)

\*4 The 4:4:4(YCbCr)12/10bit signal is displayed after converting to the 4:2:2(YCbCr)12/10bit signal.

\*5 The 4:4:4(RGB)12/10bit signal is displayed as a 4:4:4(RGB)8bit signal

# BVM-X300

4K OLED Master Monitor

## 4K 4096 x 2160 Pixel Resolution OLED Panel

The BVM-X300 incorporates a 30-inch true 4K panel at 4096 x 2160 pixel resolution. The aspect ratio is 1.89:1 (17:9) so images are mapped with no scaling processes.

## High Dynamic Range Mode

In addition to the intrinsic high-contrast performance of the TRIMASTER EL™ OLED panel, this monitor provides High Dynamic Range mode. This offers never-before-seen image reproduction – the black is black, and peak brightness can be reproduced more realistically with colors that are typically saturated in a conventional standard dynamic range. This mode can brilliantly express sparkling town lights and stars in the night sky.

Conventional standard dynamic range



Highlight is clipped; less shadow detail

High Dynamic Range mode



Render shadow detail to highlight

\*Simulated Images

## Interlace Mode

The BVM-X300 monitor offers an Interlace Display feature for 1080i input. This enables input to be presented as a true interlace display. As with the Native Scan function, Interlace Display mode offers faithful reproduction of the input signal, and the displayed interlace fields are free from the picture degradation that can occur as a result of typical I/P conversion processes.

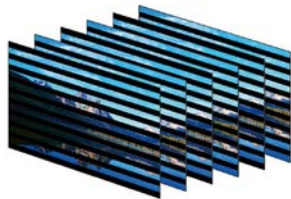

\*Simulated Image

## Supports DCI P3 and ITU-R BT.2020 Wide Color Spaces

The BVM-X300 offers industry-leading wide color gamuts. It complies with the DCI-P3 color gamut and supports the ITU-R BT.2020 color space. S-GAMUT3.cine\*<sup>1</sup> and S-GAMUT3\*<sup>1</sup> color gamuts are also supported to achieve coherent cinematography production workflow with Sony's 4K cinematography cameras.

\*<sup>1</sup> The BVM-X300 does not cover the ITU-R BT.2020, S-Gamut/S-Gamut3 and S-Gamut3.cine color space in full.

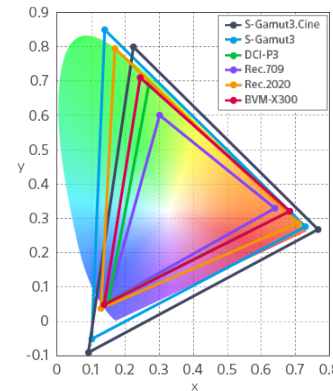

\* Simulated image

## Gamut Marker

When ITU-R BT.2020 colors out of ITU-R BT.709 or DCI-P3 color gamuts are detected, this master monitor indicates this with a zebra pattern over the relevant area of the picture. Gamut Marker is a convenient feature that instantly tells viewers to such colors.



# BVM-X300

4K OLED Master Monitor

## HDMI(HDCP2.2) and 3G-SDI Quad-link up to 4096 x 2160/48p 50p 60p, YCbCr 4:2:2 10-bit

This master monitor supports HDMI and both 2 Sample Interleave (2SI)\*1 and Square Division signals on SDI. HDMI support HD signals and 4K/UHD signals up to 50p 60p YCbCr 4:2:2 12-bit. It also supports HD signals including 3G-SDI single link for 1920 x 1080/50p 60p, YCbCr 4:2:2 10-bit, and 3G-SDI dual link for 1920 x 1080/50p 60p, 4:4:4 12/10-bit. 3G/HD-SDI Quad link and Dual link are supported for 4K/UHD and 3G/HD-SDI Single link and Dual link are supported for 2K/HD. XYZ signals \*2 as well as RGB and Y/CB/CR are supported.

\*1 SMPTE ST 2036-3 standard.  
\*2 Supported from ver.1.2.

### Rear connector panel

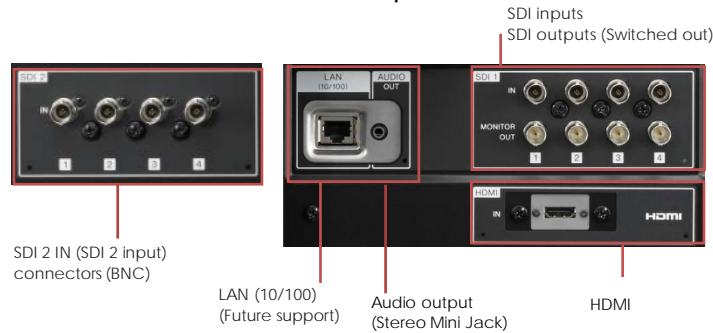

## Accurate black and color reproduction

A key advantage of TRIMASTER EL is the fact that each pixel can be turned completely off. No other display technology is able to offer this. TRIMASTER EL is capable of reproducing accurate black with each individual pixel, enabling users to evaluate each picture image faithfully to the signal.

## Quick Response with Virtually No Motion Blur

The TRIMASTER EL gray-to-gray switching speed (measured in microseconds,  $\mu$ s) is much faster than that of the LCD (measured in milliseconds, ms) \*3. This fast response benefits a variety of applications and uses.

\*3 Sony's test results.

## Extremely wide viewing angle

Sony BVM-X300 OLED TRIMASTER EL provides a superior viewing angle performance as compared to other flat panel technology available on the market. It makes easier to evaluate picture performance with a few viewers to see the same colors and contrast.

## Input Setting

To improve usability, V2.2 firmware offers new input setting features. You can aggregate all color settings and luminance settings and change them together. In addition, the number of settings has expanded from 4 to 8 settings. a

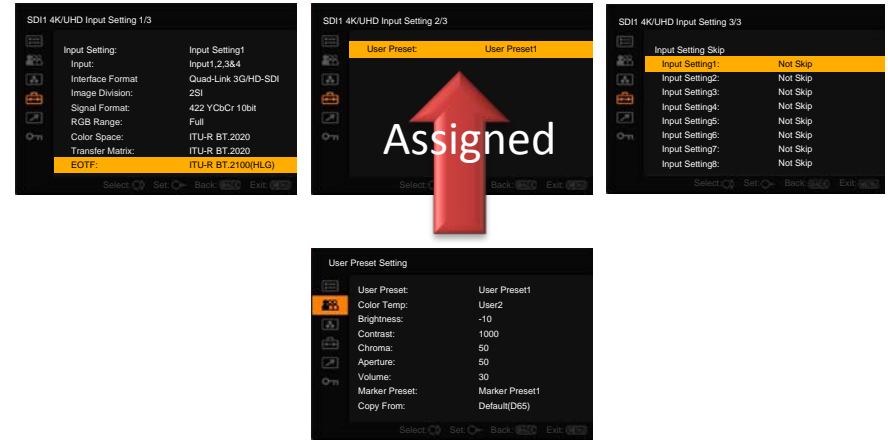

## Faster access to the status menu page\*4

BVM-X300 offers the last memory of the status menu to recall a status of the current input setting such as Color space, EOTF, User Preset and more. Once you check them from the status menu and close the menu, you can quickly see them when you open the menu again.

\*4 Supported from ver.2.0.

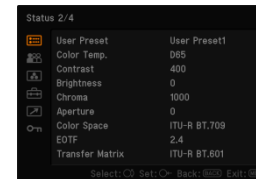

Close

Re-open



# BVM-X300

4K OLED Master Monitor

## Flicker-free Mode

The TRIMASTER EL OLED panel's superb quick response and scan-driving performance deliver stunning picture quality with virtually no motion blur. However, there is a possibility that flicker is just visible when a lower frequency signal is displayed (24p, 24PsF, and 50i). To remove visible flicker, the BVM-X300 is equipped with Flicker-free mode.

## User-friendly Built-in Control Panel

The BVM-X300 incorporates a built-in control panel in front, which offers user-friendly convenient functions:

- Seven user-assignable function buttons
- Manual controls for aperture, chroma, brightness, and contrast
- Separate 4K and 2K settings, enabling users straightforward operation
- Dimmable button lights and on/off switchable indicator lights

The front panel design offers common operability with BVM-E and BVM-F Series master monitors\*1, and close operability with PVM-A and LMD-A Series monitors. This commonality between Sony's monitors in the same chain allows users simple operation and faster feature selection.

\*1 BVM-E and BVM-F Series monitors use the optional BKM-16R and BKM-17R remote control unit.

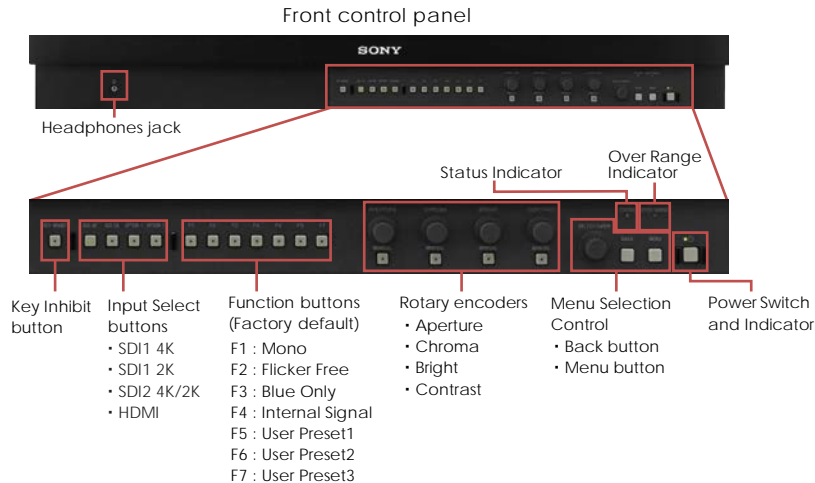

## Power-on Setting

This function allows users to select setting data when the monitor starts up; this includes last memory, user preset, and factory preset settings. Users can set the monitor accurately and quickly. This function is very useful for rental equipment.

## Password Lock for User Preset

When multiple users share the same monitor, each user can register his/her own password for color temperature and user preset data. This ensures the user correctly recalls their preset data, and keeps preset information safe from unauthorized use.

## User Presets

When multiple users share the same monitor, each user can memorize his/ her settings and retrieve this data whenever required. This frees the user from time-consuming and repetitive setting tasks. Up to five User Presets can be memorized.

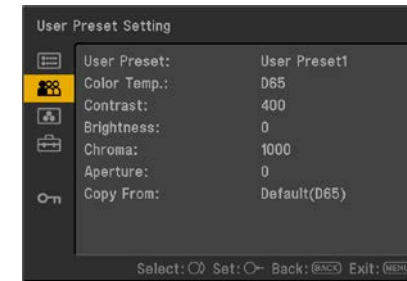

## Key Inhibit

The KEY INHIBIT button located on the front panel protects each user's settings. When a user wants to change these values, the lock can be released.

# BVM-X300

4K OLED Master Monitor

## Flexible Area Marker\*1

Two flexible area markers can be freely set anywhere on the screen. This is useful for shopping channels; these require a unique screen layout to instantly differentiate between a product and its commercial data.

\*1 Supported from ver.2.2.



Marker Preset  
Image 1

Marker Preset  
Image 2

Marker Preset  
Image 3

Example : Shopping channels



Guide for a proper framing



Zoom out to show a commercial product

## Time Code\*2

LTC and VITC time code can be displayed at the top or bottom of the picture.

\*2 Supported from ver.2.2.

## Area and aspect markers

The BVM-X300 monitor can display various markers, including an aspect marker, safe area marker, and center marker. In addition to this flexible selection of marker types, detailed display settings of each marker are offered. For example, the color, brightness, horizontal/vertical position, and width of aspect markers can all be controlled, while the height and width of safe area markers can be adjusted.

# BVM-X300

4K OLED Master Monitor

## Marker settings\*1

The BVM-X300 monitor can display various markers, including an aspect marker, safe area marker, and center marker. In addition to this flexible selection of marker types, detailed display settings of each marker are offered. For example, the color, brightness, horizontal/vertical position, and width of aspect markers can all be controlled, while the height and width of safe area markers can be adjusted.

\*1 Supported from ver.1.2.

### Marker Variation

	Safe Area Marker		Aspect Marker*
	%	Dot (Pixel)	
Selectable Markers	80%, 88%, 90%, 93%, or variable	Flexible	16:9, 15:9, 14:9, 13:9, 4:3, 2.39:1, 2.35:1, 1.896:1, 1.85:1, or 1.66:1
Line Colors	White, Red, Green, Blue, Yellow, Cyan, or Magenta		
Line Width	1 to 5 dots (factory preset at 2 dots)		
Line Luminance Intensity	High (bright) or Low (dark)		
Blanking	—		Off: Blanking is released Black: Blanking Half: Half blanking

### Marker Examples



Aspect Mode: 2.35:1,  
Safe Area: Shape A,  
Area Size: 80%



Aspect Mode: 14:9,  
Safe Area: Shape B,  
Area Size: 80%



Aspect Mode: 4:3,  
Safe Area: Shape C,  
Area Size: 80%

## Sony S-Log Gamma, Hybrid Log-Gamma and SMPTE ST 2084 Support\*2

The BVM-X300 supports conventional 2.2, 2.4, 2.6, and CRT gamma. In addition, HDR (High Dynamic Range) EOTF tables are provided for 2.4 (HDR), SMPTE ST 2084, S-Log2 (HDR), S-Log3 (HDR), SMPTE ST.2084 (HDR) and ITU-R BT.2100(HLG)\*3. S-Log3(Live HDR) offers easier camera control for High Dynamic Range (HDR) live production.

S-Log gamma is a technique used in Sony's digital cinematography cameras that allows the full latitude of the camera imager to be maintained throughout the production chain. Unlike conventional systems, in which highlight contrast is compressed, S-Log gamma logarithmically converts the video signal using characteristics similar to film negatives. This keeps the camera imager's dynamic range intact, even in extreme highlight areas. The BVM-X300 allows reproduction as an inverse function of the camera's S-Log gamma signals.

Two display modes are offered: S-Log2 and S-Log3.

Both of them enable easy workflow close to that of film, and deliver a 4K wide dynamic range. These log functions include the entire range captured by the camera. When the BVM-X300 is set to the S-Log mode, it will display this range without the need for any signal correction or user LUTs, and gives colorists complete freedom in creativity.

\*2 Supported from V1.2.

\*3 Changed V2.1.

## Other Features

- Aperture
- Internal Signal
- Wall Mounting (100 mm x 200 mm)

# BVM-E251/BVM-E171

OLED Master Monitors



BVM-E251

BVM-E171

25"/17" FHD OLED Reference Monitors for Color Critical, Quality Control Operation of Versatile video productions

## Main Features

- BVM 2<sup>nd</sup> Generation Grade OLED Panel
- Superb picture performance
- Super Top Emission™ technology
- Ultimate Sony display engine
- Multi-format signal support
- Versatile video inputs
- HDR<sup>1 2</sup>
- Flicker free mode
- ITU-R BT.2020 / DCI-P3/ ITU-R BT.709 support
- Accepts computer signals via HDMI with RGB/YCC full range support
- Auto White Balance
- Gamut error display
- S-Log3(SDR), S-Log2(SDR)
- 2K picture resolution
- High quality I/P conversion technology
- Low video delay
- Panel calibration
- Interlaced display mode
- Picture & Picture mode (Wipe, Butterfly, Blending the E series only)
- Pixel zoom mode
- Scan Switch
- Native Scan (pixel-to-pixel display)
- HD Frame Capture mode
- Separate control unit with USB
- Centralized monitor-wall control
- DC operation with DC low power indicator<sup>\*1</sup>
- Character Off button
- Copy function for monitor setup and adjustment data
- +12dB Chroma UP function
- Marker settings
- Aspect switch
- Wide variety of functions
- Status display

<sup>\*1</sup> Requires v1.1 update.

<sup>\*2</sup> BVM-E171 only and requires optional HDR Monitoring License BVML-HE171..

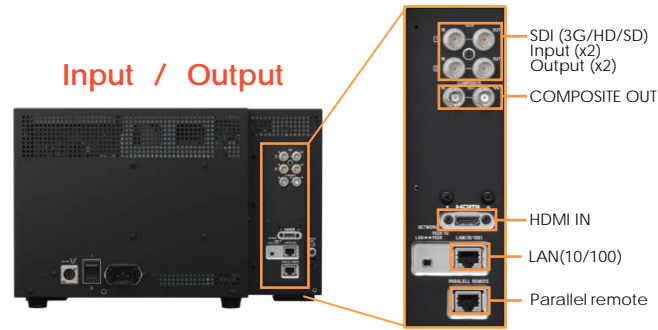

## Specifications

	BVM-E251	BVM-E171
<b>Picture Performance</b>		
Panel	OLED panel	
Picture size (diagonal)	623.4 mm (24 5/8 inches)	419.7 mm (16 5/8 inches)
Effective picture size (H x V)	543.4 x 305.6 mm (21 1/2 x 12 1/8 inches)	365.8 x 205.7 mm (14 1/2 x 8 1/8 inches)
Resolution (H x V)	1920 x 1080 pixels (Full HD)	
Aspect	16:9	
Pixel efficiency	99.99%	
Panel drive	10-bit	
Panel frame rate	48 Hz / 50 Hz / 60 Hz (48 Hz, 60 Hz are also compatible with 1/1,001 frame rates)	
Viewing angle (panel specification)	89°/89°/89°/89° (typical) (up/down/left/right contrast > 10:1)	
Standard luminance	100 cd/m2 (preset1 to preset5 at EOTF 2.4) 48 cd/m2 (preset (DCI)) (1.0 Vp-preference signal, 100% white signal input)	
Color temperature	D55, D61, D65, D93, DCI <sup>3</sup> , DCI XYZ and User1-5 (5,000K to 10,000K adjustable)	
Color space (color gamut)	ITU-R BT.2020 <sup>*4</sup> , ITU-R BT.709, EBU, SMPTE-C, DCI-P3 <sup>*4</sup> , BVM-E251 Native <sup>*5</sup> , S-GAMUT/S-GAMUT3 <sup>*4</sup> , S-GAMUT3.cine <sup>*4</sup>	ITU-R BT.2020 <sup>*4</sup> , ITU-R BT.709, EBU, SMPTE-C, DCI-P3 <sup>*4</sup> , BVM-E171 Native <sup>*5</sup> , S-GAMUT/S-GAMUT3 <sup>*4</sup> , S-GAMUT3.cine <sup>*4</sup>
Transmission Matrix	ITU-R BT.2020 (Non-constant luminance), ITU-R BT.709, ITU-R BT.601, SMPTE240M	ITU-R BT.2020 (Non-constant luminance is supported), ITU-R BT.709
EOTF	2.2, 2.4, 2.6, CRT, S-Log3(SDR), S-Log2(SDR)	2.2, 2.4, 2.6, CRT, S-Log3(SDR), S-Log2(SDR), 2.2, 2.4, 2.6, CRT, S-Log3(HDR), S-Log3(Live HDR), S-Log2(HDR), ITU-R BT.2100(HLG), SMPTE ST2084, 2.4(HDR) when BVML-HE171 activates the HDR monitoring features.
<b>Input</b>		
SDI	BNC (x2)	
HDMI	HDMI (x1) (HDCP 1.4 correspondence, Deep Color correspondence)	
Composite Video	BNC (x1)	
Parallel remote	RJ-45 modular connector 8-pin (x1), (Pin-assignable)	
Serial remote (LAN)	Ethernet (10BASE-T/100BASE-TX), RJ-45 (x1)	
DC In	XLR (x1)	
<b>Output</b>		
SDI	BNC (x2)	
Composite Video	BNC (x1)	
DC out	Circle 4-pin (female) (x1)	
<b>General</b>		
Power requirement	AC 100 V to 240 V, 1.2 A to 0.6 A, 50/60 Hz, DC 24 V to 28 V, 4.5 A to 3.9 A	AC 100 V to 240 V, 0.9 A to 0.5 A, 50/60 Hz, DC 24 V to 28 V, 3.3 A to 2.9 A
Power consumption	Approx. 117 W (AC power supply)(max.) Approx. 107 W (DC power supply)(max.) Approx. 55W (AC power supply) Approx. 51W (DC power supply) (average power consumption in the default status)	Approx. 88 W (AC power supply) (max.) Approx. 78 W (DC power supply) (max.) Approx. 53 W (AC power supply) Approx. 49 W (DC power supply) (average power consumption in the default status)
Operating temperature	0°C to 35°C (32°F to 95°F) Recommended: 20°C to 30°C (68°F to 86°F)	
Operating humidity	30% to 85% (no condensation)	
Storage and transport temperature	-20°C to +60°C (-4°F to +140°F)	
Storage and transport humidity	0% to 90%	
Operating, storage, and transport pressure	700 hPa to 1060 hPa	
Dimensions (W x H x D)	576.0 x 424.0(408.0)* x 148.0 mm (22 3/4 x 16 3/4(16 1/16)* x 5 7/8 inches) *Height without legs	436.0 x 282.4 (266.4)* x 156.5 mm (17 1/4 x 11 1/4 (10 1/2))* x 6 1/4 inches) *Height without legs
Mass	Approx. 10.3 kg (22 lb 11 oz)	Approx. 6.5 kg (14 lb 5 oz)
Supplied accessories	AC power cord (1), AC plug holder (1), CD-ROM (1), Before using this unit (Japanese, English, each 1), HDMI cable holder(1), European Representative (1)	AC power cord (1), AC plug holder (1), CD-ROM (1), Before using this unit (Japanese, English, each 1), HDMI cable holder(1), Handle(1), Rack mount bracket(2), Rack mount bracket attachment screws(4), European Representative (1)

<sup>\*3</sup> DCI: x=0.314 y=0.351

<sup>\*4</sup> The BVM-E251 and BVM-E171 does not support the ITU-R BT.2020, DCI-P3, S-Gamut/S-Gamut3 and S-Gamut3.cine color space in full.

<sup>\*5</sup> The BVM-E251 individual chromaticity points. The widest color space setting of the signal is reproduced by the BVM-E251.

<sup>\*6</sup> The BVM-E171 individual chromaticity points. The widest color space setting of the signal is reproduced by the BVM-E171.



# BVM-E251/BVM-E171

OLED Master Monitors

## Signal Formats / Input Adaptors

	Signal System	Signal Structure	Quantization
Composite	720 <sup>+</sup> X 487 / 59.94 / I	NTSC 0/7.5	Limited
	720 <sup>+</sup> X 487 / 59.94 / I	PAL-M	Limited
	720 <sup>+</sup> X 576 / 59.94 / I	PAL	Limited
SD-SDI	720 X 487 / 59.94 / I	4 : 2 : 2 (YCbCr) 10 bit	Limited
	720 X 576 / 59.94 / I	4 : 2 : 2 (YCbCr) 10 bit	Limited
HD-SDI Single Link	1920 x 1080 / 50 / I	4 : 2 : 2 (YCbCr) 10 bit	Limited
	1920 x 1080 / 60 <sup>+</sup> / I	4 : 2 : 2 (YCbCr) 10 bit	Limited
	1280 x 720 / 50 / P	4 : 2 : 2 (YCbCr) 10 bit	Limited
	1280 x 720 / 60 <sup>+</sup> / P	4 : 2 : 2 (YCbCr) 10 bit	Limited
	1920 x 1080 / 24 <sup>+</sup> / PsF	4 : 2 : 2 (YCbCr) 10 bit	Limited
	1920 x 1080 / 24 <sup>+</sup> / P	4 : 2 : 2 (YCbCr) 10 bit	Limited
	1920 x 1080 / 25 / PsF	4 : 2 : 2 (YCbCr) 10 bit	Limited
	1920 x 1080 / 25 / P	4 : 2 : 2 (YCbCr) 10 bit	Limited
	1920 x 1080 / 30 <sup>+</sup> / PsF	4 : 2 : 2 (YCbCr) 10 bit	Limited
	1920 x 1080 / 30 <sup>+</sup> / P	4 : 2 : 2 (YCbCr) 10 bit	Limited
	1280 x 720 / 24 <sup>+</sup> / P	4 : 2 : 2 (YCbCr) 10 bit	Limited
	1280 x 720 / 25 / P	4 : 2 : 2 (YCbCr) 10 bit	Limited
HD-SDI Dual Link	1920 x 1080 / 50 / I	4 : 4 : 4 (YCbCr) 10 bit	Limited
		4 : 4 : 4 (RGB) 10 bit	Limited / Full
		4 : 4 : 4 (YCbCr) 12 bit	Limited
	1920 x 1080 / 50 / I	4 : 4 : 4 (RGB) 12 bit	Limited / Full
		4 : 4 : 4 (YCbCr) 10 bit	Limited
		4 : 4 : 4 (RGB) 10 bit	Limited / Full
	1920 x 1080 / 50 / P	4 : 4 : 4 (YCbCr) 12 bit	Limited
		4 : 4 : 4 (RGB) 12 bit	Limited / Full
	1920 x 1080 / 60 <sup>+</sup> / P	4 : 2 : 2 (YCbCr) 10 bit	Limited
	1920 x 1080 / 24 <sup>+</sup> / PsF	4 : 4 : 4 (YCbCr) 10 bit	Limited
		4 : 4 : 4 (RGB) 10 bit	Limited / Full
		4 : 4 : 4 (YCbCr) 12 bit	Limited
	1920 x 1080 / 24 <sup>+</sup> / P	4 : 4 : 4 (RGB) 10 bit	Limited / Full
		4 : 4 : 4 (YCbCr) 12 bit	Limited
		4 : 4 : 4 (YCbCr) 12 bit	Limited / Full
	1920 x 1080 / 25 / PsF	4 : 4 : 4 (RGB) 12 bit	Limited / Full
		4 : 4 : 4 (YCbCr) 10 bit	Limited
		4 : 4 : 4 (RGB) 10 bit	Limited / Full
	1920 x 1080 / 25 / P	4 : 4 : 4 (YCbCr) 10 bit	Limited
		4 : 4 : 4 (RGB) 10 bit	Limited / Full
		4 : 4 : 4 (YCbCr) 12 bit	Limited
	1920 x 1080 / 30 <sup>+</sup> / PsF	4 : 4 : 4 (RGB) 10 bit	Limited / Full
		4 : 4 : 4 (YCbCr) 12 bit	Limited
		4 : 4 : 4 (RGB) 12 bit	Limited / Full
1920 x 1080 / 30 <sup>+</sup> / P	4 : 4 : 4 (YCbCr) 10 bit	Limited	
	4 : 4 : 4 (RGB) 10 bit	Limited / Full	
	4 : 4 : 4 (YCbCr) 12 bit	Limited	

	Signal System	Signal Structure	Quantization
3G-SDI	1920 x 1080 / 50 / I	4 : 4 : 4 (YCbCr) 10 bit	Limited
		4 : 4 : 4 (RGB) 10 bit	Limited / Full
		4 : 4 : 4 (YCbCr) 12 bit	Limited
		4 : 4 : 4 (RGB) 12 bit	Limited / Full
	1920 x 1080 / 50 / I	4 : 4 : 4 (YCbCr) 10 bit	Limited
		4 : 4 : 4 (RGB) 10 bit	Limited / Full
		4 : 4 : 4 (YCbCr) 12 bit	Limited
		4 : 4 : 4 (RGB) 12 bit	Limited / Full
	1280 x 720 / 50 / P	4 : 4 : 4 (YCbCr) 10 bit	Limited
		4 : 4 : 4 (RGB) 10 bit	Limited / Full
	1280 x 720 / 60 <sup>+</sup> / P	4 : 4 : 4 (YCbCr) 10 bit	Limited
		4 : 4 : 4 (RGB) 10 bit	Limited / Full
4 : 4 : 4 (YCbCr) 12 bit		Limited	
4 : 4 : 4 (RGB) 12 bit		Limited / Full	
1920 x 1080 / 24 <sup>+</sup> / PsF	4 : 4 : 4 (YCbCr) 10 bit	Limited	
	4 : 4 : 4 (RGB) 10 bit	Limited / Full	
	4 : 4 : 4 (YCbCr) 12 bit	Limited	
	4 : 4 : 4 (RGB) 12 bit	Limited / Full	
1920 x 1080 / 24 <sup>+</sup> / P	4 : 4 : 4 (YCbCr) 10 bit	Limited	
	4 : 4 : 4 (RGB) 10 bit	Limited / Full	
	4 : 4 : 4 (YCbCr) 12 bit	Limited	
	4 : 4 : 4 (RGB) 12 bit	Limited / Full	
1920 x 1080 / 25 / PsF	4 : 4 : 4 (YCbCr) 10 bit	Limited	
	4 : 4 : 4 (RGB) 10 bit	Limited / Full	
	4 : 4 : 4 (YCbCr) 12 bit	Limited	
	4 : 4 : 4 (RGB) 12 bit	Limited / Full	
1920 x 1080 / 25 / P	4 : 4 : 4 (YCbCr) 10 bit	Limited	
	4 : 4 : 4 (RGB) 10 bit	Limited / Full	
	4 : 4 : 4 (YCbCr) 12 bit	Limited	
	4 : 4 : 4 (RGB) 12 bit	Limited / Full	
1920 x 1080 / 30 <sup>+</sup> / PsF	4 : 4 : 4 (YCbCr) 10 bit	Limited	
	4 : 4 : 4 (RGB) 10 bit	Limited / Full	
	4 : 4 : 4 (YCbCr) 12 bit	Limited	
	4 : 4 : 4 (RGB) 12 bit	Limited / Full	
1920 x 1080 / 30 <sup>+</sup> / P	4 : 4 : 4 (YCbCr) 10 bit	Limited	
	4 : 4 : 4 (RGB) 10 bit	Limited / Full	
	4 : 4 : 4 (YCbCr) 12 bit	Limited	
	4 : 4 : 4 (RGB) 12 bit	Limited / Full	
1280 x 720 / 24 <sup>+</sup> / P	4 : 4 : 4 (YCbCr) 10 bit	Limited	
	4 : 4 : 4 (RGB) 10 bit	Limited / Full	
	4 : 4 : 4 (YCbCr) 12 bit	Limited	
	4 : 4 : 4 (RGB) 12 bit	Limited / Full	
1280 x 720 / 25 / P	4 : 4 : 4 (YCbCr) 10 bit	Limited	
	4 : 4 : 4 (RGB) 10 bit	Limited / Full	
	4 : 4 : 4 (YCbCr) 12 bit	Limited	
	4 : 4 : 4 (RGB) 12 bit	Limited / Full	
1280 x 720 / 30 <sup>+</sup> / P	4 : 4 : 4 (YCbCr) 10 bit	Limited	
	4 : 4 : 4 (RGB) 10 bit	Limited / Full	
	4 : 4 : 4 (YCbCr) 12 bit	Limited	
	4 : 4 : 4 (RGB) 12 bit	Limited / Full	
HD-SDI Single Link (2K)	2048 x 1080/24 <sup>+</sup> / PsF	4 : 2 : 2 (YCbCr) 10 bit	Limited
	2048 x 1080/24 <sup>+</sup> / P	4 : 2 : 2 (YCbCr) 10 bit	Limited
	2048 x 1080 / 25 / PsF	4 : 2 : 2 (YCbCr) 10 bit	Limited
	2048 x 1080 / 25 / P	4 : 2 : 2 (YCbCr) 10 bit	Limited
	2048 x 1080 / 30 <sup>+</sup> / PsF	4 : 2 : 2 (YCbCr) 10 bit	Limited
2048 x 1080 / 30 <sup>+</sup> / P	4 : 2 : 2 (YCbCr) 10 bit	Limited	

\*1 Also compatible with the frame rate 1/1.001

\*2 Displayed as masked when blanking SMPTE ST170 (480/59.94i) and ITU-R BT.470 (576/50i) horizontally.

# BVM-E251/BVM-E171

OLED Master Monitors

## Signal Formats / Input Adaptors

	Signal System	Signal Structure	Quantization	
HD-SDI Dual Link (2K)	1920 × 1080 / 24* <sup>1</sup> / PsF	4 : 4 : 4 (XYZ) 12 bit	Full	
		4 : 4 : 4 (RGB) 10 bit	Limited / Full	
		4 : 4 : 4 (RGB) 12 bit	Limited / Full	
	1920 × 1080 / 24* <sup>1</sup> / P	4 : 4 : 4 (XYZ) 12 bit	Full	
		4 : 4 : 4 (RGB) 10 bit	Limited / Full	
		4 : 4 : 4 (RGB) 12 bit	Limited / Full	
	1920 × 1080 / 25 / PsF	4 : 4 : 4 (XYZ) 12 bit	Full	
		4 : 4 : 4 (RGB) 10 bit	Limited / Full	
		4 : 4 : 4 (RGB) 12 bit	Limited / Full	
	1920 × 1080 / 25 / P	4 : 4 : 4 (XYZ) 12 bit	Full	
		4 : 4 : 4 (RGB) 10 bit	Limited / Full	
		4 : 4 : 4 (RGB) 12 bit	Limited / Full	
	1920 × 1080 / 30* <sup>1</sup> / PsF	4 : 4 : 4 (XYZ) 12 bit	Full	
		4 : 4 : 4 (RGB) 10 bit	Limited / Full	
		4 : 4 : 4 (RGB) 12 bit	Limited / Full	
	1920 × 1080 / 30* <sup>1</sup> / P	4 : 4 : 4 (XYZ) 12 bit	Full	
		4 : 4 : 4 (RGB) 10 bit	Limited / Full	
		4 : 4 : 4 (RGB) 12 bit	Limited / Full	
	3G-SDI Single Link (2K)	1920 × 1080 / 24* <sup>1</sup> / PsF	4 : 4 : 4 (XYZ) 12 bit	Full
			4 : 4 : 4 (RGB) 10 bit	Limited / Full
			4 : 4 : 4 (RGB) 12 bit	Limited / Full
		1920 × 1080 / 24* <sup>1</sup> / P	4 : 4 : 4 (XYZ) 12 bit	Full
			4 : 4 : 4 (RGB) 10 bit	Limited / Full
			4 : 4 : 4 (RGB) 12 bit	Limited / Full
1920 × 1080 / 25 / PsF		4 : 4 : 4 (XYZ) 12 bit	Full	
		4 : 4 : 4 (RGB) 10 bit	Limited / Full	
		4 : 4 : 4 (RGB) 12 bit	Limited / Full	
1920 × 1080 / 25 / P		4 : 4 : 4 (XYZ) 12 bit	Full	
		4 : 4 : 4 (RGB) 10 bit	Limited / Full	
		4 : 4 : 4 (RGB) 12 bit	Limited / Full	
1920 × 1080 / 30* <sup>1</sup> / PsF		4 : 4 : 4 (XYZ) 12 bit	Full	
		4 : 4 : 4 (RGB) 10 bit	Limited / Full	
		4 : 4 : 4 (RGB) 12 bit	Limited / Full	
1920 × 1080 / 30* <sup>1</sup> / P		4 : 4 : 4 (XYZ) 12 bit	Full	
		4 : 4 : 4 (RGB) 10 bit	Limited / Full	
		4 : 4 : 4 (RGB) 12 bit	Limited / Full	

## HDMI and DisplayPort Input Signal Formats

Signal System	Interface sampling frequency [MHz]	Aspect ratio	Standard	Quantization
<b>Video Signals</b>				
640 x 480 / 60* <sup>1</sup> / P	25.200 <sup>1</sup>	4:3	CEA-861	Full
720 x 480 / 60* <sup>1</sup> / P	27.027 <sup>1</sup>	4:3/16:9		Limited
1280 x 720 / 60* <sup>1</sup> / P	74.250 <sup>1</sup>	16:9		Limited
1920 x 1080 / 60* <sup>1</sup> / I	74.250 <sup>1</sup>	16:9	CEA-861	Limited
		2.39:1		
720 x 480 / 60* <sup>1</sup> / I	27.027 <sup>1</sup>	4:3/16:9	CEA-861	Limited
720 x 576 / 50 / P	27.000	4:3/16:9		Limited
1280 x 720 / 50 / P	74.250	16:9		Limited
1920 x 1080 / 50 / I	74.250	16:9	CEA-861	Limited
		2.39:1		
720 x 576 / 50 / I	27.000	4:3/16:9	CEA-861	Limited
1920 x 1080 / 60* <sup>1</sup> / P	148.500 <sup>1</sup>	16:9	CEA-861	Limited
		2.39:1		
1920 x 1080 / 50 / P	148.500	16:9	CEA-861	Limited
		2.39:1		
1920 x 1080 / 24* <sup>1</sup> / P	74.250 <sup>1</sup>	16:9	CEA-861	Limited
		2.39:1		
1920 x 1080 / 25 / P	74.250	16:9	CEA-861	Limited
		2.39:1		
1920 x 1080 / 30* <sup>1</sup> / P	74.250 <sup>1</sup>	16:9	CEA-861	Limited
		2.39:1		
2048 x 1080 / 24* <sup>1</sup> / P	74.250 <sup>1</sup>	1.896:1		Limited
		2.39:1		
2048 x 1080 / 25 / P	74.250	1.896:1		Limited
		2.39:1		
2048 x 1080 / 30* <sup>1</sup> / P	74.250 <sup>1</sup>	1.896:1		Limited
		2.39:1		
2048 x 1080 / 60* <sup>1</sup> / P	148.500 <sup>1</sup>	1.896:1		Limited
		2.39:1		
2048 x 1080 / 50 / P	148.500	1.896:1		Limited
		2.39:1		
2048 x 1080 / 48 / P	148.500 <sup>1</sup>	1.896:1		Limited
		2.39:1		
<b>Computer Signals</b>				
800 x 600 / 60 / P	40.000	4:3	Wall	Limited
1024 x 768 / 60 / P	65.000	4:3		Limited
1280 x 960 / 60 / P	108.000	4:3		Limited
1280 x 1024 / 60 / P	108.000	5:4		Full
1400 x 1050 / 60 / P	121.750	4:3		Full

\*1 Also compatible with the frame rate 1/1.001

# BVM-E251/BVM-E171

OLED Master Monitors

## Dimensions

### BVM-E251

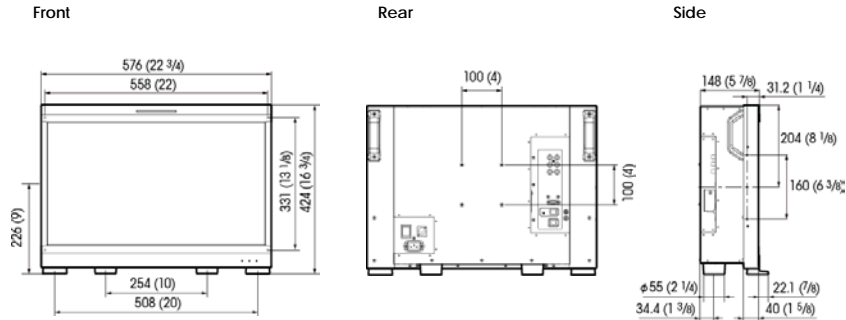

### BVM-E251 with the optional BKM-17R and BKM-37H with a tilt

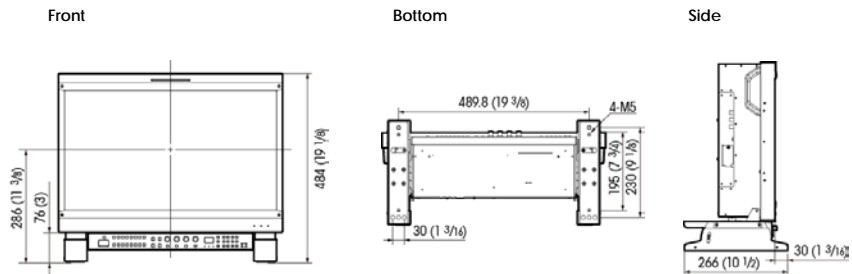

### BVM-E251 with the optional BKM-17R and BKM-38H

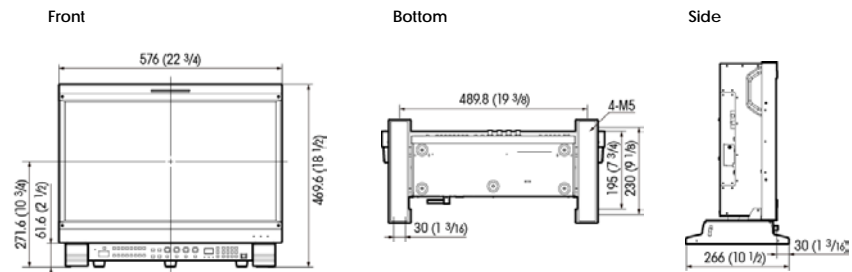

### BVM-E171

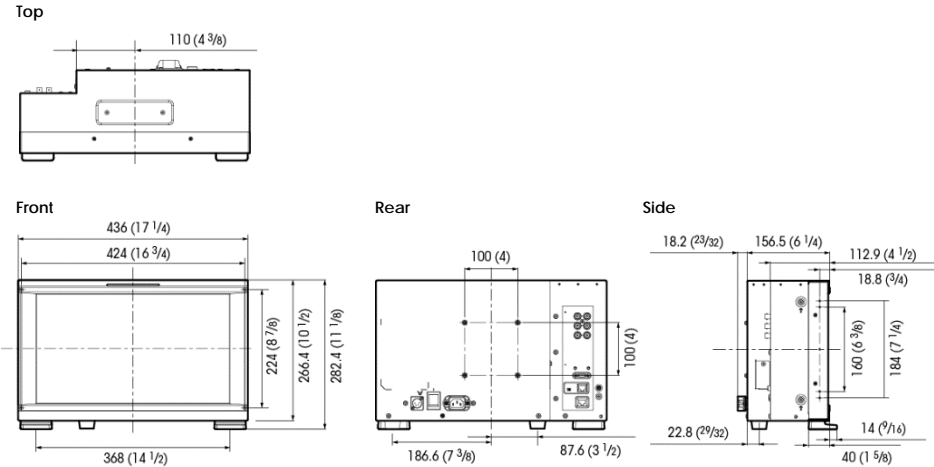

### BVM-E171 with the optional BKM-17R and BKM-39H

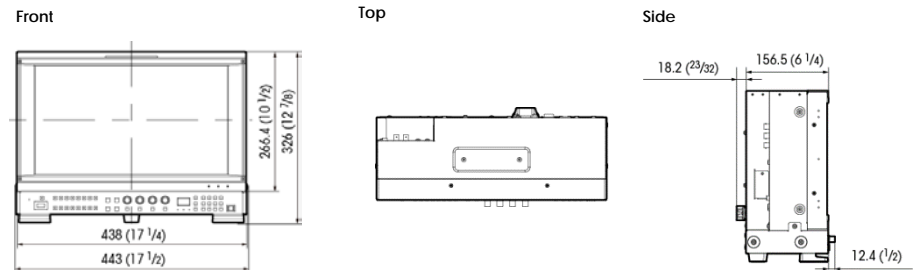

### BKM-17R

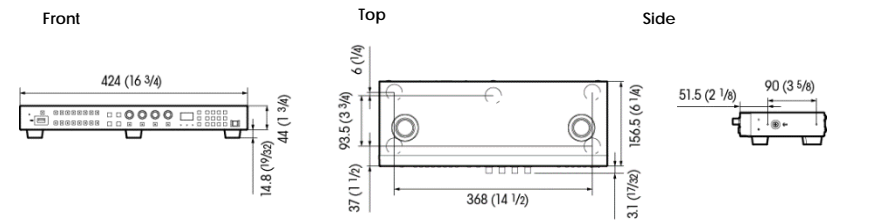

Unit: mm (inches)

# BVM-E251/BVM-E171

OLED Master Monitors

## Options



### BKM-17R Monitor Control Unit

The BVM-E 251/E171 monitors and the BKM-17R Monitor Control Unit are equipped with an Ethernet port, allowing remote control of display parameters across a standard Ethernet connection. One BKM-17R Monitor Control Unit can control up to thirty-two (32) BVM\*1 monitors.

\*1 Includes BVM-X300, PVM-X550, BVM-L, PVM-L, and BVM-E/F Series monitors.



### BKM-17R Specifications

INPUT/OUTPUT	
LAN	10BASE-T/100BASE-TX connector: RJ-45 (x1)
DC 12 V IN	Circle pin (x1)
USB (USB2.0) connector	USB Standard A (x1)
GENERAL	
Power requirements	DC IN: 12 V, 0.5 A (supplied with the connected monitor or the connected AC adapter) AC adapter (AC-UES1230 or ACUES1230M) AC adaptor: AC IN: 100 V to 240 V, 50/60 Hz, DC OUT: 12 V, 3 A
Current consumption	12 V DC, 0.5 A
Power consumption	Approx. 6 W
Operating temperature	0°C to 35°C (32°F to 95°F), Recommended: 20°C to 30°C (68°F to 86°F)
Operating humidity	0% to 90% (no condensation)
Operating pressure	700 hPa to 1060 hPa
Storage / transport temperature	-10°C to +40°C (14°F to 104°F)
Storage/transport humidity	0% to 90%
Operating / storage / transport pressure	700 hPa to 1060 hPa
Dimensions(W x H x D)	424 x 58.8 x 169.6 mm (16 3/4 x 2 3/8 x 6 3/4 inches)
Mass	2.1 kg (4 lb 10 oz)
Supplied accessories	AC adapter (AC-UES1230 or ACUES1230M)(1), AC power cord (1), Rack mount brackets (2), Rack mount bracket attachment screws(4), Function labels (2), DC-cord secure connection attachment (1), DC-cord secure connection screw (1), Before Using This Unit (1), CD-ROM (1), European Representative (1)

### Fantastic HDR Performance

The fantastic HDR images enabled on the BVM-E171 Version 1.1 by the BVML-HE171 HDR Monitoring License include wide color gamut and OLED black pictures with pixel dimming and great off-axis performance.

### Activate With The BKM-17R Monitor Control Unit

To activate these HDR features, you need a BKM-17R Monitor Control Unit and a install key. Your Sony sales representative can provide a purchase key. Your next step is to visit the Sony eCSite to input the unique device ID is shown on an OSD of your BVM-E171 V1.1 and your purchase key. You then receive your install key, which you should download and save to USB memory. Whenever required, you can now insert the USB memory stick in the BKM-17R to activate the HDR features of your BVM-E171 V1.1.



**BKM-37H\*3**  
Controller Attachment Stand with tilt (Between 5° forward and 10° backward.)  
(For BVM-E251)



**BKM-38H\*3**  
Controller Attachment Stand  
(For BVM-E251)



**BKM-39H\*3**  
Controller Attachment Stand  
(For BVM-E171)



**SMF-17R20**  
Monitor Interface Cable

\*3 Requires the latest version of the BKM-37H, BKM-38H, and BKM-39H with a product code suffix /3 or later.

### BVML-HE171 HDR Monitoring License

A permanent license allows the BVM-E171 TRIMASTER EL™ OLED Critical Reference Monitor\*2 to support excellent HDR images. Called the BVML-HE171 HDR Monitoring License, it supports EOTF, S-Log3 (HDR), S-Log3 (Live HDR), S-Log2 (HDR), ITU-R BT.2100 (HLG), and SMPTE ST2084, 2.4 (HDR).

\*2 The BVM-E171 must first be updated to V1.1. HDR features are activated via the BKM-17R Monitor Control Unit.

## What's the difference between BVM and PVM?

### Master Monitor

BVM-E251/E171



#### Basic Quality

Selected Best Panel Only for BVM

Sony Designed OLED 12bit Engine

#### Reference Monitoring Features

- ITU-R BT.2020/DCI-P3 support
- HDR\*1
- Interlace mode
- High precision I/P conversion
- XYZ signal support
- Two Area Markers
- Gamut error
- Pixel Zoom
- Aspect correction for SD signal

#### On-set Monitoring Features

- DC Operation(25"/17": 24V to 28V)
- Picture & Picture
- Chroma up
- S-Log3/S-Log2

### Picture Monitor

PVM-A250/A170



Standard Panel

Standard 10 bit Engine

- ITU-R BT.2020/DCI-P3 support\*2
- Flexible Marker\*2

- DC Operation(17":11V to 16V)
- DC Low power indicator
- Light weight
- Low power consumption
- Optional Protection Panel
- Camera Focus Assist
- WFM/Vector
- Grid display
- Picture & Picture
- Chroma up
- Flip H/V
- Camera metadata
- Anamorphic display
- S-Log2(SDR)\*2
- S-Log3(SDR)\*2
- False Color\*2
- Sync-Free Side By Side\*2

\*1 BVM-E171 V1.1 only with HDR Monitoring License BVML-HE171.

\*2 Supported with V2.0



# BVM-E251/E171

OLED Master Monitors

## ITU-R BT.2020 support enabled OLED's wide color gamut

The BVM-E251 and BVM-E171 are surely an HD monitor that conforms to ITU-R BT.709 color space. Responding to an increase of the demand of using an HD monitor in a 4K production, BVM-E251 newly supports ITU-R BT.2020 color space and transfer matrix. The OLED's wide color gamut enables DCI-P3 emulation for digital intermediate work.\*1

\*1 The BVM-E251 and BVM-E171 does not support the ITU-R BT.2020, S-Gamut,/S-Gamut3, S-Gamut3.cine and DCI-P3 color space in full.

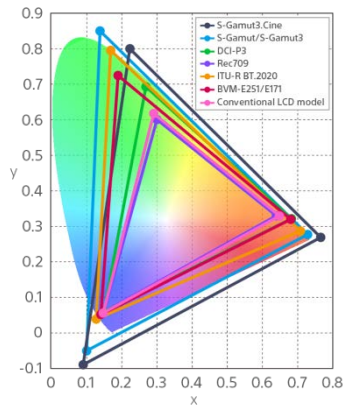

## Cutting-edge I/P conversion with low process delay

Sony's original I/P conversion technology used in the BVM Series minimizes processing artifacts found in typical up conversion processes. This has been improved in the BVM-L Series so that an interlaced image is displayed accurately and faithfully. The process delay times of 1080/60i and 50i are around 0.5 field or less and also the ones of SD/60i and 50i are less than 1 field.

## Flicker free mode

The TRIMASTER EL OLED panel's superb quick response and scan-driving performance deliver stunning picture quality with virtually no motion blur. However, there is a possibility that flicker is just visible especially when a lower frequency signal is displayed (24p, 24PsF, and 50i). To remove visible flicker, the BVM-E251 and BVM-E171 are equipped with Flicker-free mode.

## High Dynamic Range Mode

In addition to the intrinsic high-contrast performance of the TRIMASTER EL™ OLED panel, this monitor provides High Dynamic Range mode\*2. This offers never-before-seen image reproduction – the black is black, and peak brightness can be reproduced more realistically with colors that are typically saturated in a conventional standard dynamic range. This mode can brilliantly express sparkling town lights and stars in the night sky.

\*2 Only for BVM-E171 V1.1. BVML-HE171 is required for BVM-E171 V1.1.

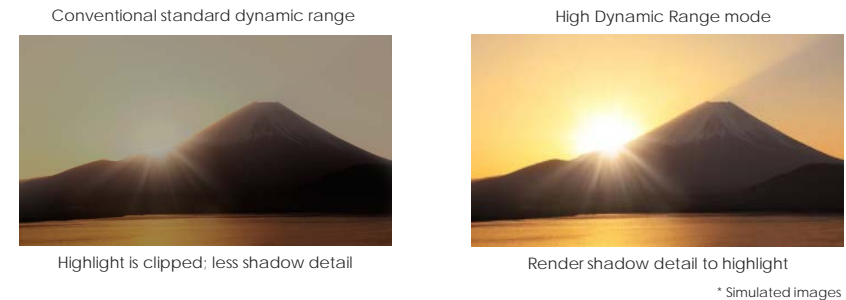

## Input Versatility

### Multi-format signal support

The BVM-E251 and BVM-E171 can accept almost any SD or HD video format, such as analogue composite video, HDMI and SDI, and various computer signals through HDMI

### Standard 3G-SDI inputs

These monitors are equipped with two standard 3G/HD/SD-SDI inputs, an HDMI (HDCP correspondence) and composite input. Two standard inputs also support dual link HD-SDI signals. And also closed caption on SDI is supported.

### 12-bit output accuracy signal processing

The BVM-E251 and E171 use a 12-bit display engine, which allows images to be reproduced with high precision for display accuracy.

### Accepts computer signals via HDMI

The BVM-E251 and BVM-E171 accepts various computer signals input up to 1920 x 1080 through its HDMI connector. It is also equipped with Digital Cinema 2048x1080 signals.

# BVM-E251/E171

OLED Master Monitors

## Exclusive BVM-E Series Digital Cinema Features

The BVM-E251 and E171 offers digital cinema features which are indispensable and ideal for high-quality creative digital cinema onset and post-production workflow.

### 2K (2048 x 1080, RGB/XYZ) Input

The BVM-E251 and E171 are capable of 2K (2048 x 1080 resolution, RGB/XYZ) input. The 2K signal is displayed in two ways – as a full 2K image scaled into a full-HD (1920 x 1080) screen, or as a 2K native display with an image-slide function.

### 2K picture resolution

The 2048 Image-slide function allows 2K resolution (2048 x 1080 pixels) images to be mapped, pixel-to-pixel, on the full-HD (1920 x 1080 pixels) panel without picture degradation. When the user needs to view the left or right edge of the picture frame, they can scroll the image in a horizontal direction.



### S-Log3(SDR) and S-Log2(SDR) EOTF

S-LOG gamma is a technique used in Sony's digital cinematography cameras that allows the full latitude of the camera imager to be maintained throughout the production chain. Unlike conventional systems, in which highlight contrast is compressed, S-LOG Gamma logarithmically converts the video signal using characteristics similar to film negatives. This keeps the camera imager dynamic range intact, even in extreme highlight areas. Two display modes are offered:

The BVM-E171 V1.1 activated by BVML-HE171 supports HDR display only.

### Gamut Error Display

This function detects irregular signal input. When an irregular signal is detected, these master monitors indicate this with a zebra pattern over the relevant area of the picture.

Gamut Error Display is a convenient feature that instantly alerts viewers to such signals without requiring the use of a waveform monitor



# BVM-E251/E171

OLED Master Monitors

## Signal Analyzing Functions

### Picture & Picture

The unique Picture & Picture function of the BVM-E251 and E171 allows simultaneous display of two input signals on the monitor's screen. This function is extremely convenient for making instant adjustments to two input sources, because there is no need to individually adjust the different characteristics of two monitors. This function comes in handy for adjustments between two cameras, special-effects creation, time-lapse shooting, and computer graphics (CG) work.

### Side-by-side

The two picture images are downscaled using a digital filter and displayed side-by-side. This feature is convenient when making white balance adjustments or determining shooting angles between two cameras.



### WIPE

The area of the two pictures to be displayed is selected using a vertical WIPE pattern, which is controlled from the BKM-17R. This function is useful when picture detail of the two images must be examined on a pixel basis. This is normally used to review still images.



### Butterfly

The two inputs are displayed as line-symmetric images on the left and right halves of the screen. By adjusting the H-position controller, the two images can be moved inward to the middle of the screen. An instant comparison of the moving images can then be made easily and accurately, without the user having to move their eyes.

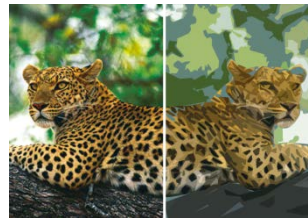

### Blending

The two picture images are overlapped for display, and the mix ratio is adjustable. This function is useful to verify whether a foreground signal is accurately keyed into the background signal, or when combining shoots with live action and computer-generated effects.



### Pixel Zoom

Pixel Zoom\*1 is a function for magnifying images. A selected area of the displayed picture can be enlarged on a pixel basis, up to eight times in size both vertically and horizontally. Because this function does not use scaling, the desired picture content is magnified and displayed faithfully to the raw input signal. This function is useful when evaluating precise picture edges, such as for chroma keying.

\*1 This function is effective when the input signal is displayed in "Native Scan" mode.

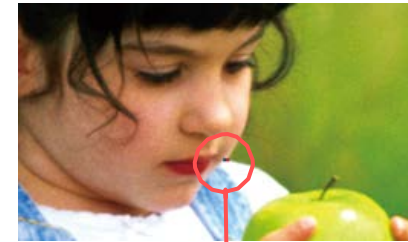

Error Signal

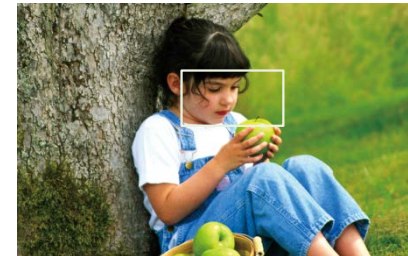

# BVM-E251/E171

OLED Master Monitors

## Convenient Features

### Interlace Display

BVM-E251 and E171 monitors offer an Interlace Display feature for 1080i and SD inputs. This lets each BVM-E monitor display these inputs as a true interlace display. As with the Native Scan function, Interlace Display mode offers faithful reproduction of the input signal, and the displayed interlace fields are free from the picture degradation that can occur as a result of typical I/P conversion processes.

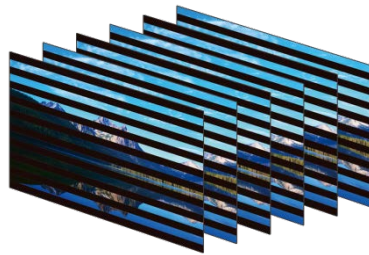

\*Simulated image

### Scan Switch

The Scan Switch function allows switching between under scan (-3%), normal scan (0%), and over scan (mask of the 5% over scan portion in the normal scan).

### Native Scan (pixel-to-pixel display)

Conventional flat-panel monitors reproduce images using scaling and I/P conversion due to their fixed pixel counts and progressive scanning processes. The Native Scan function is a unique display mode that reproduces images without changing the input signal's pixel count. For example, when an SD signal is input, the BVM-E251 and E171 monitors will reproduce the image at a picture size of 720 x 487\*1 pixels. For SD inputs the Native Scan function also allows the displayed image size to be doubled to 1440 x 974\*1 by duplicating and doubling each pixel both horizontally and vertically.

\*1 The 525/59.94i signal specified by Rec. ITU-R BT.601.



720 x 487 Native Scan



1440 x 974 Native Scan  
(720 x 487) x 2

### HD Frame Capture

The HD Frame Capture function of the BVM-E251 and E171 allows a picture frame from the 3G-SDI and HD-SDI input to be captured and saved as a picture file on a USB memory media (BKM-17R). This picture file can be used as a reference for various purposes, for example, for picture-tone adjustments between past images and for camera-framing adjustments.

### Aspect Correction Mode

PAL and NTSC video systems are all based on rectangular pixels. Display of these formats on a square pixel panel typically distorts the image. The BVM-E251 and E171 use a unique process called Aspect Correction which, while still offering native pixel performance, continues to display image geometry correctly. This scaling technique used in BVM-E251 and E171 corrects horizontal distortion while keeping the vertical pixel count correctly displayed.

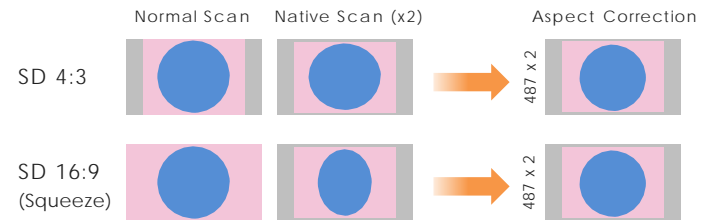

Example of NTSC signal on the 16:9 aspect panel - BVM-E250A

### Aspect switch

The aspect ratio can be switched between 4:3, 16:9, 2.39:1, and 1.896:1 depending on the input signal.

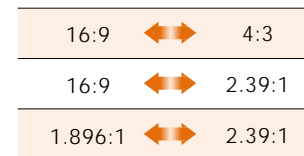

# BVM-E251/E171

## OLED Master Monitors

### Marker settings

BVM-E251 and E171 monitors can display various markers, including an aspect marker, safe area marker, and center marker. In addition to this flexible selection of marker types, detailed display settings of each marker are offered. For example, the color, brightness, horizontal/vertical position, and width of aspect markers can all be controlled, while the height and width of safe area markers can be adjusted.

#### Marker Variation

	Safe Area Maker		Aspect Marker*
	%	Dot (Pixel)	
Selectable Markers	80%, 88%, 90%, 93%, or variable	Flexible	16:9, 15:9, 14:9, 13:9, 4:3, 2.39:1, 2.35:1, 1.896:1, 1.85:1, or 1.66:1
Line Colors	White, Red, Green, Blue, Yellow, Cyan, or Magenta		
Line Width	1 to 5 dots (factory preset at 2 dots)		
Line Luminance	High (bright) or Low (dark)		
Blanking	—		Off: Blanking is released Black: Blanking Half: Half blanking

#### Marker Examples



Aspect Mode: 2.35:1,  
Safe Area: Shape A,  
Area Size: 80%



Aspect Mode: 14:9,  
Safe Area: Shape B,  
Area Size: 80%



Aspect Mode: 4:3, Safe  
Area: Shape C, Area  
Size: 80%

### Wide Variety of Functions

The user has a wide variety of over 40 functions to choose from. Each of these can be assigned to any of the 16 function buttons (F1 to F16) on the BKM-17R controller. Press ENTER to display the F1 to F8 (or F9 to F16) button assignment on screen.



ENTER button

F1 to F16 function buttons

- F9 : FLICKER FREE
- F10 : NATIVE SCAN
- F11 : INTERLACE
- F12 : MARKER
- F13 : SIDE BY SIDE
- F14 : ALM
- F15 : TIME CODE
- F16 : CAPTURE LOAD

(The next Function display)

\*Screen image is simulated

### Status Display

Simply assign STATUS to one of the function buttons (F1 to F16) on the BKM-17R controllers. The user can instantly grasp the whole monitor status and configurations without having to search through menus.



F1 to F16 function buttons

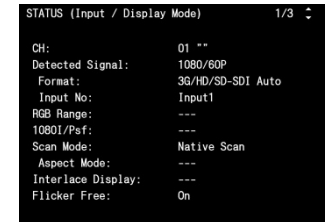

\*Screen image is simulated



# BVM-E251/E171

OLED Master Monitors

## Modular Monitor Control Unit (BKM-17R)

BVM-E251 and BVM-E171 monitors and their control panels are provided as separate units, allowing greater flexibility for system integration. BVM-E251 and E171 incorporate a monitor control unit (the BKM-17R) as an option. The BKM-17R can be attached beneath the monitor using the optional controller attachment stand<sup>\*1,2</sup>, or connected remotely via an Ethernet cable.

\*1 Requires the latest version of the BKM-37H, BKM-38H, and BKM-39H with a product code suffix /3 or later.

\*2 The BVM-E251 use the BKM-37H or BKM-38H attachment stand.

The BVM-E171 use the BKM-39H attachment stand.

## Copy function for monitor setup and adjustment data

Copy function for monitor setup and adjustment data

The optional BKM-17R control unit includes a USB memory slot to save and load monitor configuration and adjustment settings. This is useful for multiple monitor systems, allowing the transfer of one monitor's setup and adjustment data to another.\*<sup>3</sup>

This data can also be transferred via the BVM's Ethernet connection.

\*<sup>3</sup> Data can be moved between BVM-E251 and BVM-E171 monitors.

## " +12dB Chroma UP" function

A "Chroma UP" button located on the front panel of the BKM-17R allows the Chroma level to be boosted by +12 dB.

This is a convenient feature for adjusting camera white balance with a higher degree of accuracy.

## Ethernet-based remote control

The BVM-E251 and BVM-E171 monitors and the BKM-17R Monitor Control Unit are equipped with an Ethernet port, allowing remote control of display parameters across a standard Ethernet connection. One BKM-17R Monitor Control Unit can control up to thirty-two (32) BVM<sup>\*4</sup> monitors.

\*<sup>4</sup> Includes BVM-X300, PVM-X550, monitors, BVM-L, PVM-L, and BVM-E/-F Series monitors.

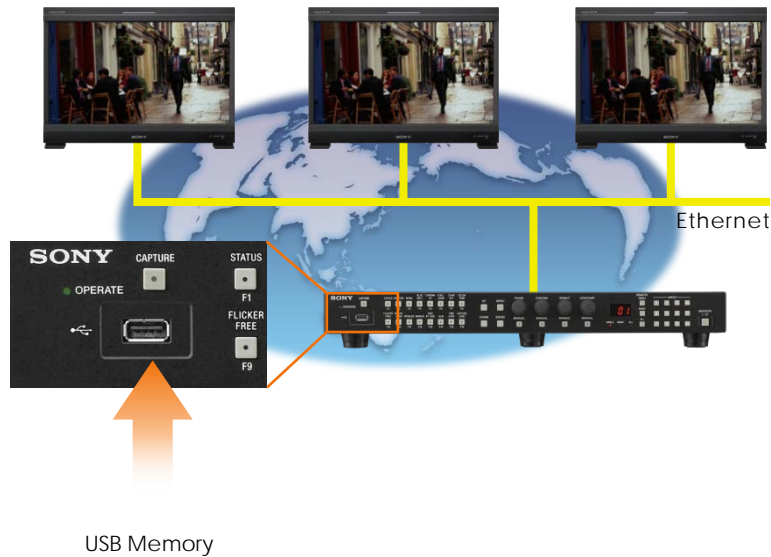



# BVM-E251/E171

OLED Master Monitors

## Easy Setup and Adjustment

### Auto White Adjustment

The BVM-E251 and E171 employ a software-based color temperature (white balance) calibration function, which is called "Monitor\_AutoWhiteAdjustment". Combined with a PC and commercially available calibration tools\*1, this function enables simple adjustment of the monitor's white balance.

\*1 Konica Minolta CA-210, CA-310, CS-200, DK-Technologies PM5639/06, X-Rite i1 Pro/i1 Pro2, Photo Research PR-655/670, Klein K-10, and JETI specbos 1211. A connector is required for each color analyzer.

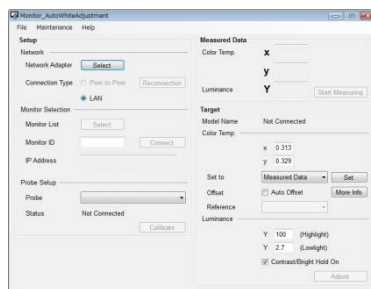

"Monitor\_AutoWhiteAdjustment" GUI image

### "Character Off" button

To facilitate parameter adjustments, the On-Screen Menu indication can be taken off the screen, while in Menu mode. The On-Screen Menu indication can be toggled on or off with a simple press of a button on the BKM-17R's front panel.

### Auto Chroma / Phase adjustment\*2

An Auto Chroma / Phase / Matrix setup function is provided on BVM-E251 and E171, which automatically adjusts the monitor's chroma, phase, and matrix using external color bars.

\*2 Supports analog signal inputs only.

### DC Operation With DC Low Power Indicator\*3

The BVM-E251 and BVM-E171 can be DC operated and features a DC low power indicator. The BVM-E251 provides more flexibility and mobility to users who want a larger size screen for on-set applications. Due to its lightweight and slim design, the BVM-E171 is ideal for field applications.

\*3 Requires V1.1 update.

BVM-E171 rear view



### Tilting the monitor

The monitor can tilt between 5° forward and 10° backward when the attachment stand is attached.

### Other features

- Wall Mounting (100 x 100 mm pitch)
- EIA 19-inch Standard Rack-mountable (6U High)\*4
- Blue Only
- Mono
- H Delay / V Delay\*5
- NTSC Setup Level (0%, 7.5%)
- Aperture
- Serial Remote (Ethernet)
- Parallel Remote (D-sub 9-pin)
- Tally Lamp (Amber)

\*4 BVM-E171 only. Mounting brackets are supplied.

\*5 This function does not work for a composite signal.

# PVM-X550

4K TRIMASTER EL™ OLED Picture Monitor



55" Large screen 4K OLED Picture Monitor for precision color grading and quality control

## Main Features

- 55 -inch Large 4K OLED panel
- 3840 x 2160 Pixel Resolution
- High Brightness Mode<sup>\*3</sup>
- Accurate black and color reproduction
- Quad view display
- Wide viewing angle
- Supports DCI-P3 and ITU-R BT.2020 wide color spaces<sup>\*1</sup>
- Gamut Marker (ITU-R BT.2020 colors outside 709 or DCI-P3)
- Quick Response
- High Dynamic Range (S-Log2(HDR), S-Log3(HDR), S-Log3(Live HDR), ITU-R BT.2100(HLG)<sup>\*2</sup>, SMPTE ST.2084(HDR))
- Multi-format capability
- New Input Setting recall(Input, Color and Luminance setting)<sup>\*3</sup>
- Flexible Marker<sup>\*3</sup>
- Versatile 4K/QFHD Input Capability
- 3G-SDI Quad-link up to 4096 x 2160/48p 50p 60p, YCbCr 4:2:2 10-bit
- HD-SDI Dual-link and 4K/2K XYZ signals
- Flicker free mode
- Power-on Setting
- User Presets
- Password Lock for User Preset
- Time code display<sup>\*3</sup>
- Built-in Control Panel
- BKM-16R and BKM-17R control

<sup>\*1</sup> The PVM-X550 does not cover the DCI-P3 and BT.2020 color space in full.

<sup>\*2</sup> Changed from V1.1.

<sup>\*3</sup> Supported from V2.0.

Picture Performance	
Panel	OLED Panel
Picture size (diagonal)	1387.832 mm (54.6 inches)
Effective picture size (H x V)	1209.6 x 680.4 mm ( 47 5/8 x 26 7/8 inches )
Resolution (H x V)	3840 x 2160 pixels
Aspect	16:9
Pixel efficiency	99.99%
Panel drive	10-bit
Viewing angle (panel specification)	89°/89°/89°/89° (typical) (up/down/left/right contrast > 10:1)
Color temperature	D55, D61, D65, D93, DCI <sup>*4</sup> , DCI XYZ, and user 1-5 (5,000 K to 10,000 K adjustable)
Standard luminance	100 cd/m2 (100% white signal input)
Color space (color gamut)	ITU-R BT.2020 <sup>*5</sup> , ITU-R BT.709, EBU, SMPTE-C, DCI-P3 <sup>*5</sup> , PVM-X550 Native <sup>*6</sup> , S-Gamut/S-Gamut3, S-Gamut3_cine
Transmission Matrix	ITU-R BT.2020 (Non-constant luminance is supported), ITU-R BT.709
EOTF	2.2, 2.4, 2.6, CRT, 2.4 (HDR), S-Log3 (HDR), S-Log2 (HDR), SMPTE ST 2084(HDR), S-Log3 (Live HDR), ITU-R BT.2100(HLG) <sup>*2</sup>
Input	
SDI (3G/HD)	BNC (x4) x 2 sets Input impedance: 75 ohms unbalanced
HDMI	HDMI (x1) (HDCP Version2.2)
Serial remote (LAN)	Ethernet (10BASE-T/100BASE-TX), RJ-45 (x1)
Output	
SDI	BNC (x4) x 2 sets Out put impedance: 75 ohms unbalanced
Audio monitor	Stereo mini jack (x1)
General	
Power requirements	AC 100 V to 240 V, 5.7 A to 2.3 A, 50/60 Hz
Power consumption	Approx. 500 W (max.) Approx. 290 W (average power consumption in the default status)
Operating temperature	0°C to 35°C (32°F to 95°F) Recommended: 20° C to 30° C (68° F to 86° F)
Operating humidity	30% to 85% (no condensation)
Storage and transport temperature	-20°C to +60°C ( -4° F to +140° F)
Storage and transport humidity	0% to 90%
Operating / storage / transport pressure	700 hPa to 1060 hPa
Dimensions (W x H x D)	1241.6 x 718.4 x 83.5 mm (without monitor feet) (49 x 28 3/8 x 3 3/8 inches) (without monitor feet) 1241.6 x 737.2 x 205 mm (with monitor feet) (49 x 29 1/8 x 8 1/8 inches) (with monitor feet)
Mass	22.9 kg ( 50 lb 8 oz ) (With stand) 22.6 kg ( 49 lb 13 oz ) (Without stand)
Supplied accessories	AC power cord (1), AC plug holder (1), HDMI cable holder (1), Before Using This Unit (1), CD-ROM (1), Stands(2), Screws for Stands(8)

<sup>\*4</sup> DCI: x=0.314 y=0.351

<sup>\*5</sup> The PVM-X550 does not support the DCI-P3 and ITU-R BT.2020 color space in full.

<sup>\*6</sup> The PVM-X550 individual chromaticity points. The widest color space setting of the signal is reproduced by the PVM-X550 .

## Dimensions

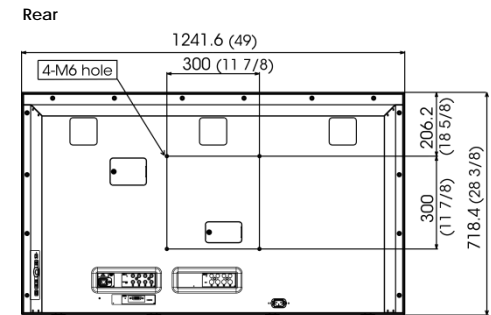
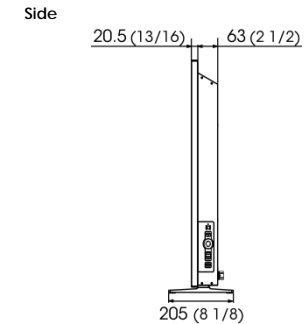
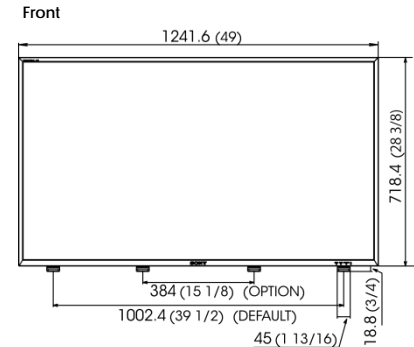

Unit: mm (inches)

### Signal Format

Signal System	Signal Format		
<b>HD-SDI Single-link</b>			
1920 × 1080/60i*1, 50i, 30p*1, 30PsF*1, 25p, 25PsF, 24p*1, 24PsF*1			
1280 × 720/60p*1, 50p, 30p*1, 25p, 24p*1	4 : 2 : 2 YCbCr	10 bit	
2048 × 1080/30p*1, 30PsF*1, 25p, 25PsF, 24p*1, 24PsF*1			
<b>2K/HD (HD-SDI Dual Link)</b>			
1920 × 1080/60p*1, 50p	4 : 2 : 2 YCbCr	10 bit	
1920 × 1080/60i*1, 50i, 30p*1, 30PsF*1, 25p, 25PsF, 24p*1, 24PsF*1	4 : 4 : 4 RGB 4 : 4 : 4 YCbCr	10 bit / 12 bit	
2048 × 1080/60p*1, 50p, 48p*1	4 : 2 : 2 YCbCr	10 bit	
2048 × 1080/30p*1, 30PsF*1, 25p, 25PsF, 24p*1, 24PsF*1	4 : 4 : 4 RGB 4 : 4 : 4 YCbCr	10 bit / 12 bit	
2048 × 1080/30p, 30PsF, 25p, 25PsF, 24p, 24PsF	4 : 4 : 4 XYZ	12 bit	
<b>4K/UHD (HD-SDI Quad Link)</b>			
3840 × 2160/30p*1, 25p, 24p*1	4 : 2 : 2 YCbCr	10 bit	Square division
3840 × 2160/30PsF*1, 25PsF, 24PsF*1			
4096 × 2160/30p*1, 25p, 24p*1	4 : 2 : 2 YCbCr	10 bit	Square division
4096 × 2160/30PsF*1, 25PsF, 24PsF*1			
<b>2K/HD (3G-SDI)</b>			
1920 × 1080/60p*1, 50p	4 : 2 : 2 YCbCr	10 bit	Level A / Level B-DL
1920 × 1080/60i*1, 50i, 30p*1, 30PsF*1, 25p, 25PsF, 24p*1, 24PsF*1	4 : 4 : 4 RGB 4 : 4 : 4 YCbCr	10 bit / 12 bit	Level A / Level B-DL
1280 × 720/60p*1, 50p, 30p*1, 25p, 24p*1	4 : 4 : 4 RGB 4 : 4 : 4 YCbCr	10 bit	Level A
2048 × 1080/60p*1, 50p, 48p*1	4 : 2 : 2 YCbCr	10 bit	Level A / Level B-DL
2048 × 1080/30p*1, 30PsF*1, 25p, 25PsF, 24p*1, 24PsF*1	4 : 4 : 4 RGB 4 : 4 : 4 YCbCr	10 bit / 12 bit	Level A / Level B-DL
	4 : 4 : 4 XYZ	12 bit	
<b>2K/HD (3G-SDI Dual Link)</b>			
1920 × 1080/60p*1, 50p	4 : 4 : 4 RGB 4 : 4 : 4 YCbCr	10 bit / 12 bit	Level A / Level B-DL
2048 × 1080/60p*1, 50p, 48p*1	4 : 4 : 4 RGB 4 : 4 : 4 YCbCr	10 bit / 12 bit	Level A / Level B-DL
<b>4K/UHD (3G-SDI Dual Link)</b>			
3840 × 2160/30p*1, 25p, 24p*1	4 : 2 : 2 YCbCr	10 bit	Level B-DS*2 2-sample interleave division / Square division
3840 × 2160/30PsF*1, 25PsF, 24PsF*1	4 : 2 : 2 YCbCr	10 bit	Level B-DS*2 Square division
4096 × 2160/30p*1, 25p, 24p*1	4 : 2 : 2 YCbCr	10 bit	Level B-DS*2 2-sample interleave division / Square division
4096 × 2160/30PsF*1, 25PsF, 24PsF*1	4 : 2 : 2 YCbCr	10 bit	Level B-DS*2 Square division
<b>4K/UHD (3G-SDI Quad Link)</b>			
3840 × 2160/60p*1, 50p	4 : 2 : 2 YCbCr	10 bit	Level A / Level B-DL 2-sample interleave division / Square division
3840 × 2160/30p*1, 25p, 24p*1	4 : 4 : 4 RGB 4 : 4 : 4 YCbCr	10 bit / 12 bit	Level A / Level B-DL 2-sample interleave division / Square division
3840 × 2160/30PsF*1, 25PsF, 24PsF*1	4 : 4 : 4 RGB 4 : 4 : 4 YCbCr	10 bit / 12 bit	Level A / Level B-DL Square division
4096 × 2160/60p*1, 50p, 48p*1	4 : 2 : 2 YCbCr	10 bit	Level A / Level B-DL 2-sample interleave division / Square division
4096 × 2160/30p*1, 25p, 24p*1	4 : 4 : 4 RGB 4 : 4 : 4 YCbCr	10 bit / 12 bit	Level A / Level B-DL 2-sample interleave division / Square division
	4 : 4 : 4 XYZ	12 bit	
4096 × 2160/30PsF*1, 25PsF, 24PsF*1	4 : 4 : 4 RGB 4 : 4 : 4 YCbCr	10 bit / 12 bit	Level A / Level B-DL Square division
	4 : 4 : 4 XYZ	12 bit	

\*1 1/1.001 is also supported.

\*2 When Square is selected (physically same when 2SI is selected).

### Signal Format

HDMI			
640 × 480/60p*1	4 : 4 : 4 RGB	8 bit / 10 bit / 12 bit	CEA-861-D
	4 : 4 : 4 YCbCr	12 bit	
	4 : 2 : 2 YCbCr	12 bit	
720 × 480/60p*1	4 : 4 : 4 RGB	8 bit / 10 bit / 12 bit	CEA-861-D
	4 : 4 : 4 YCbCr	12 bit	
	4 : 2 : 2 YCbCr	12 bit	
720 × 576/50p	4 : 4 : 4 RGB	8 bit / 10 bit / 12 bit	CEA-861-D
	4 : 4 : 4 YCbCr	12 bit	
	4 : 2 : 2 YCbCr	12 bit	
1280 × 720/60p*1 , 50p	4 : 4 : 4 RGB	8 bit / 10 bit / 12 bit	CEA-861-D
	4 : 4 : 4 YCbCr	12 bit	
	4 : 2 : 2 YCbCr	12 bit	
1920 × 1080/60i*1 , 50i	4 : 4 : 4 RGB	8 bit / 10 bit / 12 bit	CEA-861-D
	4 : 4 : 4 YCbCr	12 bit	
	4 : 2 : 2 YCbCr	12 bit	
1920 × 1080/60p*1, 50p, 30p*1, 25p, 24p*1	4 : 4 : 4 RGB	8 bit / 10 bit / 12 bit	CEA-861-D
	4 : 4 : 4 YCbCr	12 bit	
	4 : 2 : 2 YCbCr	12 bit	
2048 × 1080/60p*1, 50p, 30p*1, 25p, 24p*1	4 : 4 : 4 RGB	8 bit / 10 bit / 12 bit	No Standard
	4 : 4 : 4 YCbCr	12 bit	
	4 : 2 : 2 YCbCr	12 bit	
3840 × 2160/60p*1*2, 50p*2	4 : 4 : 4 RGB	8 bit *3	CEA-861-F
	4 : 4 : 4 YCbCr	12 bit*3	
	4 : 2 : 2 YCbCr	12 bit*3	
	4 : 2 : 0 YCbCr	8 bit	
3840 × 2160/30p*1*2, 25p*2, 24p*1*2	4 : 4 : 4 RGB	8 bit / 10 bit / 12 bit	CEA-861-F
	4 : 4 : 4 YCbCr	12 bit	
	4 : 2 : 2 YCbCr	12 bit	
4096 × 2160/60p*1*2, 50p*2	4 : 4 : 4 RGB	8 bit *3	CEA-861-F
	4 : 4 : 4 YCbCr	12 bit*3	
	4 : 2 : 2 YCbCr	12 bit*3	
	4 : 2 : 0 YCbCr	8 bit	
4096 × 2160/30p*1*2, 25p*2, 24p*1*2	4 : 4 : 4 RGB	8 bit / 10 bit / 12 bit	CEA-861-F
	4 : 4 : 4 YCbCr	12 bit	
	4 : 2 : 2 YCbCr	12 bit	
800 × 600/60p	4 : 4 : 4 RGB	8 bit / 10 bit / 12 bit	VESA and Industry Standards and Guidelines for Computer Display Monitor Timing(DMT)
	4 : 4 : 4 YCbCr	12 bit	
	4 : 2 : 2 YCbCr	12 bit	
1024 × 768/60p	4 : 4 : 4 RGB	8 bit / 10 bit / 12 bit	VESA and Industry Standards and Guidelines for Computer Display Monitor Timing(DMT)
	4 : 4 : 4 YCbCr	12 bit	
	4 : 2 : 2 YCbCr	12 bit	

\*1 Also compatible with 1/1.001.

\*2 This signal is described as "equivalent of 4K signal" in this manual.

\*3 [Enhanced Format] must be selected in the [HDMI Signal Format] menu.

Also, to input the high-resolution HDMI signal (18-Gbps), use a Premium High Speed HDMI cable to a maximum length of 3 meters.

High-resolution HDMI signal (18-Gbps): 4:4:4 RGB/YCbCr or 4:2:2 YCbCr signals with a resolution of 3840 × 2160 or 4096 × 2160/50P, 60P.

# PVM-X550

4K TRIMASTER EL™ OLED Picture Monitor

## Large Screen 4K (3840 x 2160 Pixel Resolution) OLED Panel Design

The PVM-X550 incorporates a 55-inch 4K panel at 3840 x 2160 pixel resolution. The aspect ratio is 1.78:1 (16:9) for 4096 x 2160 images, users can select scaling mode (letter box) or pixel to pixel (side cut).



## High Dynamic Range Display

In addition to the intrinsic high-contrast performance of the TRIMASTER EL OLED panel, this monitor provides High Dynamic Range display. This offers never-before-seen image reproduction – the black is black, and peak brightness can be reproduced more realistically with colors that are typically saturated in a conventional standard dynamic range. This mode can brilliantly express sparkling town lights and stars in the night sky.

Conventional standard dynamic range



Highlight is clipped; less shadow detail

High Dynamic Range display



Render shadow detail to highlight

\* Simulated images

## High Brightness Mode

As 4K and HDR production increases rapidly in the industry, there is a growing need for 4K and HDR picture evaluation. To meet this demand, Sony has enhanced the PVM-X550 with firmware updates providing a high brightness mode. This delivers a higher dynamic range to reproduce more realistic picture.

## Quad View Display Function

The PVM-X550 has Quad-view Display Function\*1, which allows customized individual display settings across four distinct views, including:

- Electro-Optical Transfer Function (EOTF)
- Color Space, Transfer Matrix, and Color Temperature
- Contrast, Brightness and Chroma
- Interface (3G-SDI, HD-SDI including Single Link/Dual Link and HDMI)
- Signal Structure (RGB and YC<sub>B</sub>C<sub>R</sub>)

An example application for quad-view display in production would be viewing the original footage on Screen A, EOTF converted image on Screen B, another EOTF converted image on Screen C, and EOTF/color space converted image on Screen D.

\*1 Input the HD signals. The down converting function is not available with this unit. Any four HD signals can be displayed by selecting from SDI1 and HDMI, or SDI2 and HDMI.

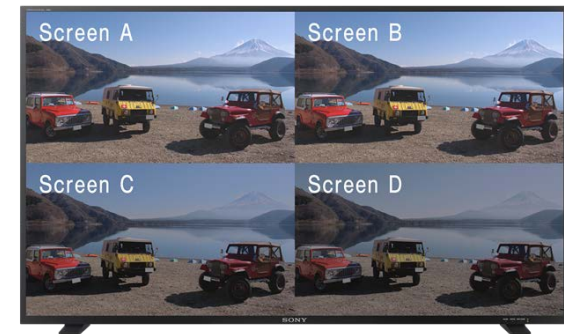

\* Simulated image

## Gamut Marker

When Rec.2020 colors out of Rec.709 or DCI-P3 color gamuts are detected, this picture monitor indicates this with a zebra pattern over the relevant area of the picture. Gamut Marker is a convenient feature that instantly tells viewers to such colors.

# PVM-X550

4K TRIMASTER EL™ OLED Picture Monitor

## Supports DCI P3 and ITU-R BT.2020 Wide Color Spaces

The PVM-X550 supports industry-leading wide color gamuts, including the DCI-P3 color gamut and ITU-R BT.2020 color space\*1. S-GAMUT3.cine and S-GAMUT3 color gamuts are also supported to achieve coherent cinematography production workflow with Sony's 4K cinematography cameras.

\*1 The PVM-X550 does not conform to DCI-P3 or the BT.2020 color space in full.

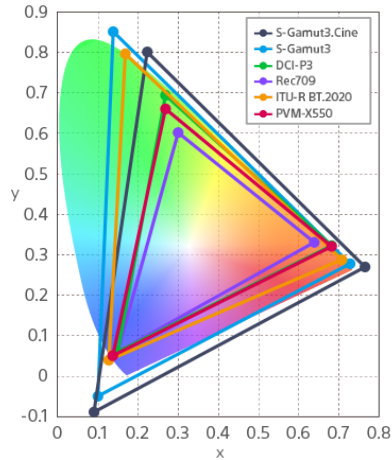

\* Simulated image

## Flexible Installation

The PVM-X550's thin bezel and lightweight design make it ideal for wall mounting, which is a particular benefit for integration into live production environments where space is often at a premium.

Where you attach the removable monitor stand can be selected from two positions depending on your installation space.

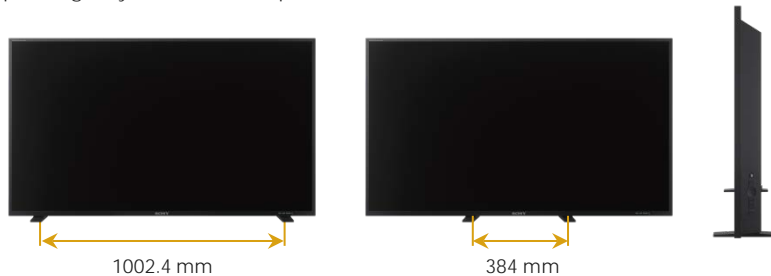

## Remote Control

The BKM-16R and BKM-R17R can be used to control all functions of the PVM-X550 remotely with easy operation. Many functions can be assigned to function buttons (F1~F16) of the BKM-16R and BKM-17R, and also "User Preset" and "Input Setting" etc. can be assigned to its numeric buttons (1~9). Besides, the numeric "0" button is used to start the panel calibration. A number of Sony's monitors (BVM, PVM and LMD series) in a same subnetwork can be controlled by one BKM-16R and BKM-17R. So if you have already used BKM-16R and BKM-17R in your system, you can add the PVM-X550 to your system easily.



## Ethernet-based remote control

The BVM, PVM, and LMD Series monitors and the BKM-16R and BKM-17R Monitor Control Unit are equipped with an Ethernet port, allowing remote control of display parameters across a standard Ethernet connection. One Monitor Control Unit can control up to thirty-two (32) monitors.

## BKM-17R Monitor Control Unit (Optional)

Front Panel



Rear Panel





# PVM-X550

4K TRIMASTER EL™ OLED Picture Monitor

## Versatile 4K/QFHD Input Capability

The PVM-X550 is equipped with standard 3G/HD-SDI input interfaces (x4) and supports 4K 2-sample interleave signals\*1 and 4K square division signals. This monitor accepts up to 3840 x 2160/24, 25, 30, 50, 60p and 4096 x 2160/24, 25, 30, 50, 60p signals.

\*1 SMPTE ST 2036-3 standard.

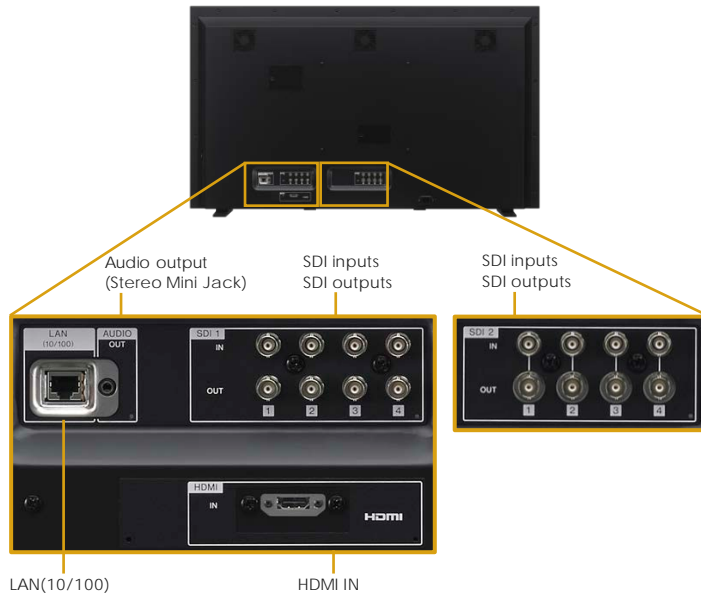

## Power-on Setting

This function allows users to select setting data when the monitor starts up: this includes last memory, user preset, and factory preset settings. Users can set the monitor accurately and quickly. This function is very useful for rental equipment.

## Password Lock for User Preset

When multiple users share the same monitor, each user can register his/her own password for color temperature and user preset data. This ensures the user correctly recalls their preset data, and keeps preset information safe from unauthorized use.

## Input Settings

To improve usability, V2.0 firmware offers new input setting features. You can aggregate all color settings and luminance settings and change them together. In addition, the number of settings has expanded from 4 to 8 settings.

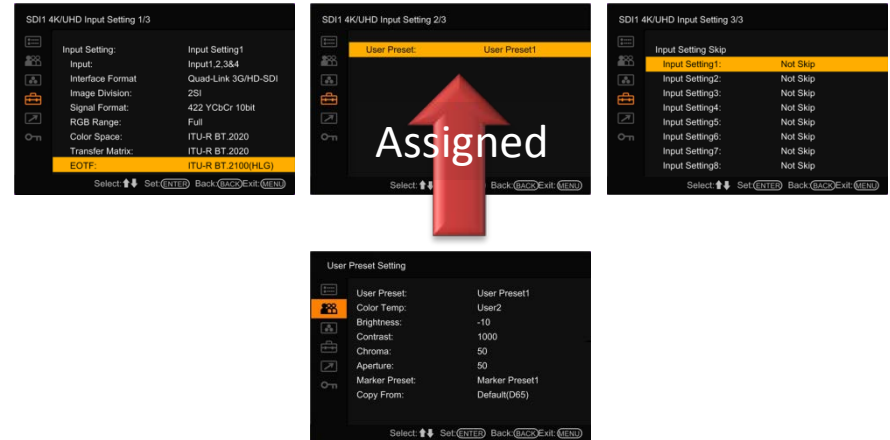

## Sony S-Log Gamma, SMPTE ST 2084 and Hybrid Log-Gamma Support

The PVM-X550 supports conventional 2.2, 2.4, 2.6, and CRT gamma. In addition, HDR (High Dynamic Range) EOTF tables are provided for 2.4 (HDR), S-Log2 (HDR), S-Log3 (HDR), S-Log3 (Live HDR)\*2, SMPTE ST.2084 (HDR) and ITU-R BT.2100 (HLG)\*2. The 2.4 (HDR) Gamma mode is for monitoring content using 2.4 gamma containing high dynamic imaging.

S-Log gamma is a technique used in Sony's digital cinematography cameras that allows the full latitude of the camera imager to be maintained throughout the production chain. Unlike conventional systems, in which highlight contrast is compressed, S-Log gamma logarithmically converts the video signal using characteristics similar to film negatives.

This keeps the camera imager's dynamic range intact, even in extreme highlight areas. The PVM-X550 allows reproduction as an inverse function of the camera's S-Log gamma signals. Two display modes are offered: S-Log2 and S-Log3.

Both of them enable easy workflow close to that of film, and deliver a 4K wide dynamic range. These log functions include the entire range captured by the camera. When the PVM-X550 is set to the S-Log mode, it will display this range without the need for any signal correction or user LUTs, and gives colorists complete freedom in creativity.

\*2 Changed from V1.1.

# PVM-X550

4K TRIMASTER EL™ OLED Picture Monitor

## User Presets

When multiple users share the same monitor, each user can memorize his/ her settings and retrieve this data whenever required. This frees the user from time-consuming and repetitive setting tasks. Up to five User Presets can be memorized.

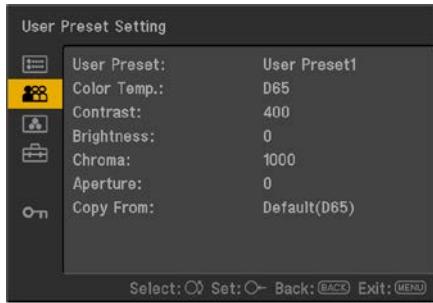

## Time code\*1

LTC and VITC time code can be displayed at the top or bottom of the picture.

\*1 Supported from ver.2.0.

## Flexible Area Marker\*2

Two flexible area markers can be freely set anywhere on the screen. This is useful for shopping channels; these require a unique screen layout to instantly differentiate between a product and its commercial data.

\*2 Supported from ver.2.0.



Example : Shopping channels

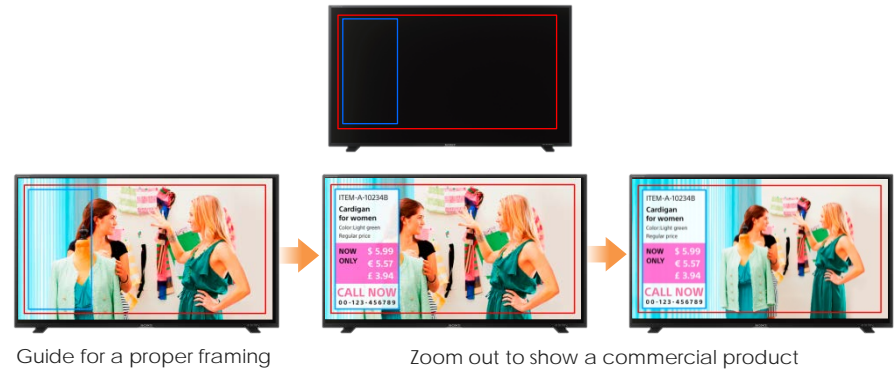

# PVM-X550

4K TRIMASTER EL™ OLED Picture Monitor

## Marker settings

The PVM-X550 monitor can display various markers, including an aspect marker, safe area marker, and center marker. In addition to this flexible selection of marker types, detailed display settings of each marker are offered. For example, the color, brightness, horizontal/vertical position, and width of aspect markers can all be controlled, while the height and width of safe area markers can be adjusted.

### Marker Variation

	Safe Area Maker		Aspect Marker
	%	Dot (Pixel)	
Selectable Markers	80%, 88%, 90%, 93%, or variable	Flexible	16:9, 15:9, 14:9, 13:9, 4:3, 2.39:1, 2.35:1, 1.896:1, 1.85:1, or 1.66:1
Line Colors	White, Red, Green, Blue, Yellow, Cyan, or Magenta		
Line Width	1 to 5 dots (factory preset at 2 dots)		
Line Luminance	High (bright) or Low (dark)		
Blanking	—		Off: Blanking is released Black: Blanking Half: Half blanking

### Marker Examples



Aspect Mode: 2.35:1,  
Safe Area: Shape A,  
Area Size: 80%



Aspect Mode: 14:9,  
Safe Area: Shape B,  
Area Size: 80%



Aspect Mode: 4:3, Safe  
Area: Shape C, Area  
Size: 80%

## Other Features

- Aperture
- Internal Signal
- Wall Mounting (300 mm x 300 mm)



# PVM-A250/PVM-A170

OLED Picture Monitors



Durable, Slim & Light-weight 25"/17" FHD OLED Monitors for Versatile Applications

## Main Features

- PVM Grade OLED Panel
- Dramatically improved viewing angle
- Super Top Emission™ technology
- Ultimate Sony display engine
- Slim and lightweight – easy to carry
- 4K production features\*1
- Shopping channels feature(Flexible Marker)\*1
- Enhanced field application features\*1
- Graphics applications features\*1
- Accurate black reproduction
- Accurate color reproduction
- Quick response with virtually no motion blur
- Video input versatility
- Optional protection kit
- Yoke-mount and Wall-mount capability
- Room clearance connector panel design
- Waveform monitor, vector scope, and audio level meter display\*2
- Camera focus function\*2
- Auto white adjustment\*2
- Picture & Picture function\*2
- 2K (2048 x 1080) input and image-slide\*2
- Camera/lens metadata display function and on-screen tally\*2
- Anamorphic image conversion and Active Format Description\*2
- Grid Display, two Center Markers and Flip functions\*
- User Presets with password lock and short-cut to function key configuration\*2
- Power-on setting
- DC Low Power indicator \*2 (PVM-A170 only)
- Optimised low-latency I/P conversion
- Multiple monitors upgrade utility\*2
- Detachable handle (PVM-A170 only)

\*1 Supported with V2.0

\*2 Supported with V1.1

	PVM-A250	PVM-A170
<b>Picture Performance</b>		
Panel	OLED panel	
Picture size(Diagonal)	623.4 mm(24 5/8 inches)	419.7 mm (16 1/2 inches)
Effective picture size (H x V)	543.4 x 305.6 mm (21 1/2 x 12 1/8 inches)	365.8 x 205.7 mm (14 1/2 x 8 1/8 inches)
Resolution (H x V)	1920 x 1080 pixels (Full HD)	1920 x 1080 pixels (Full HD)
Aspect	16:9	
Panel drive	10-bit	
Viewing angle (Panel specification)	89°/89°/89°/89° (typical) (up/down/left/right contrast > 10:1)	
<b>Input</b>		
Composite input	BNC (x1), 1.0 Vp-p ±3dB sync negative	
SDI input	BNC (x2)	
HDMI input	HDMI (x1) (HDCP correspondence)	
Audio input	Stereo mini jack (x1), -5 dBu 47 kΩ or higher	
Parallel remote	RJ-45 modular connector 8-pin (x1) (Pin-assignable)	
Serial remote (LAN)	RJ-45 modular connector (x1) (Ethernet, 10BASE-T/100BASE-TX)	
DC input	-	XLR-type 4-pin (male) (x1) DC 12 V to 16 V (output impedance 0.05 Ω or less)
<b>Output</b>		
Composite output	BNC (x1), Loop-through, with 75 Ω automatic termination	
SDI output	BNC (x2) Output signal amplitude: 800 mVp-p ±10% Output impedance: 75 Ω unbalanced	
Audio monitor output	Stereo mini jack (x1)	
Speaker (built-in) output	1.0 W (mono)	
Headphone output	Stereo mini jack (x1)	
<b>General</b>		
Power requirements	AC 100 V to 240 V, 1.3 A to 0.6 A, 50/60 Hz	AC 100 V to 240 V, 0.9 A to 0.5 A, 50/60 Hz DC 12 V to 16 V, 6.4 A to 4.8 A
Power consumption	Approx. 115 W (max.) Approx. 80 W (average power consumption in the default status)	Approx. 75 W (AC power supply) (max.) Approx. 60 W (AC power supply) (average power consumption in the default status)
Operating temperature	0°C to 35°C (32°F to 95°F) Recommended: 20°C to 30°C (68°F to 86°F)	
Operating humidity	30% to 85% (no condensation)	
Storage / Transport temperature	-20°C to +60°C (-4°F to +140°F)	
Storage / Transport humidity	0% to 90%	
Operating / Storage / Transport pressure	700 hPa to 1060 hPa	
Dimensions (W x H x D)	581.0 x 386.6 x 65.5 mm (22 7/8 x 15 1/4 x 25/8 inches) (without monitor feet) 581.0 x 409.1 x 165.0 mm (22 7/8 x 16 1/8 x 6 1/2 inches) (with monitor feet)	435.0 x 274.0 x 65.5 mm*3 (17 1/4 x 10 7/8 x 25/8 inches) (without monitor feet) 435.0 x 296.5 x 165.0 mm (17 1/4 x 11 3/4 x 6 1/2 inches) (with monitor feet)
Mass	Approx. 6.1 kg (13 lb 7.2 oz)	Approx. 4.2 kg (9 lb 4.2 oz)
Supplied accessories	AC power cord (1), AC plug holder (1), Before Using This Unit (1), CD-ROM (1)	AC power cord (1), AC plug holder (1), Handle (1)(including 4 screws), Before Using This Unit (1), CD-ROM (1)
Optional accessories	SU-561 Monitor Stand, BKM-PP25 Protection kit	SU-561 Monitor Stand, MB-P17 Mounting bracket, BKM-PP17 Protection kit

\*3 Without projection parts.

## Input/Output

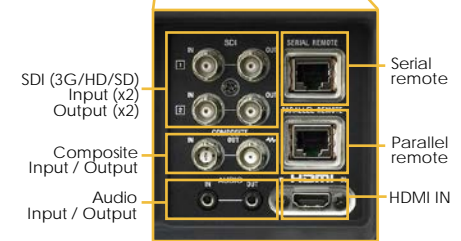

# PVM-A250/PVM-A170

OLED Picture Monitors

## Dimensions

### PVM-A250

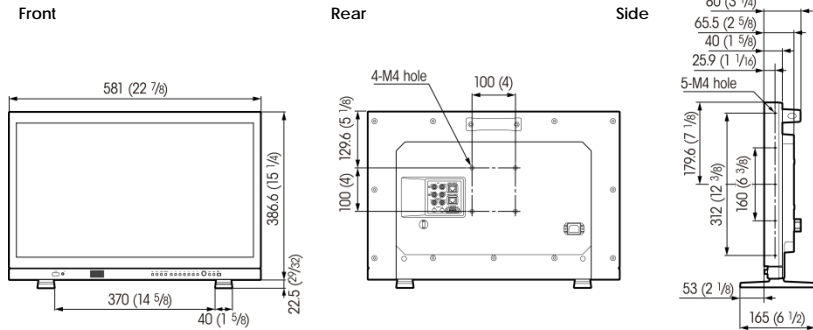

### PVM-A170

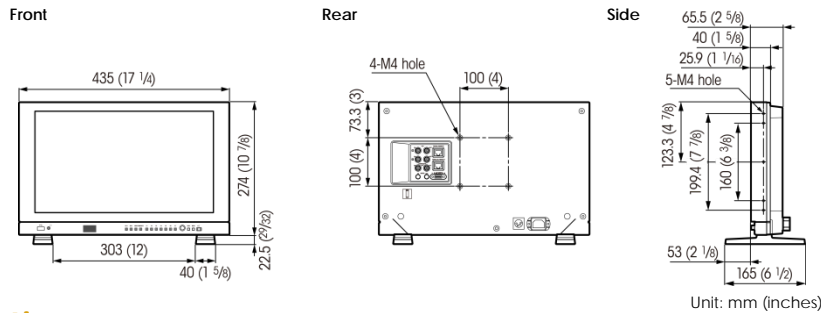

## Options

For PVM-A250 and PVM-A170

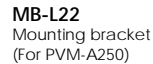
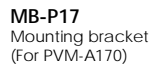
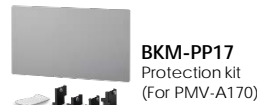

## Formats

### PVM-A250 / PVM-A170

System	Analog composite	Signal standard			HDMI
		SD/HD	SDI Dual link <sup>5</sup>	3G	
575/50i (PAL)	○	○	-	-	○
480/60i (NTSC) <sup>1</sup>	○	○	-	-	○
576/50p	-	-	-	-	○
480/60p <sup>1</sup>	-	-	-	-	○
640 x 480/60p <sup>1</sup>	-	-	-	-	○
1920 x 1080/24PsF <sup>1,2</sup>	-	○	○ <sup>3</sup>	○ <sup>3</sup>	-
1920 x 1080/25PsF <sup>2</sup>	-	○	○ <sup>3</sup>	○ <sup>3</sup>	-
1920 x 1080/30PsF <sup>1,2</sup>	-	○ <sup>5</sup>	○ <sup>3</sup>	○ <sup>3</sup>	-
1920 x 1080/24p <sup>1</sup>	-	○	○ <sup>3</sup>	○ <sup>3</sup>	○
1920 x 1080/25p	-	○	○ <sup>3</sup>	○ <sup>3</sup>	○
1920 x 1080/30p <sup>1</sup>	-	○	○ <sup>3</sup>	○ <sup>3</sup>	○
1920 x 1080/50i	-	○	○ <sup>3</sup>	○ <sup>3</sup>	○
1920 x 1080/60i <sup>1</sup>	-	○	○ <sup>3</sup>	○ <sup>3</sup>	○
1920 x 1080/50p	-	-	○ <sup>4</sup>	○ <sup>4</sup>	○
1920 x 1080/60p <sup>1</sup>	-	-	○ <sup>4</sup>	○ <sup>4</sup>	○
1280 x 720/24p <sup>1</sup>	-	○	-	-	-
1280 x 720/25p	-	○	-	-	-
1280 x 720/30p <sup>1</sup>	-	○	-	-	-
1280 x 720/50p	-	○	-	○ <sup>3</sup>	○
1280 x 720/60p <sup>1</sup>	-	○	-	○ <sup>3</sup>	○
2048 x 1080/24PsF <sup>1,2,5</sup>	-	○	○ <sup>3</sup>	○ <sup>3</sup>	-
2048 x 1080/25PsF <sup>2,5</sup>	-	○	○ <sup>3</sup>	○ <sup>3</sup>	-
2048 x 1080/30PsF <sup>1,2,5</sup>	-	○	○ <sup>3</sup>	○ <sup>3</sup>	-
2048 x 1080/24p <sup>1,5</sup>	-	○	○ <sup>3</sup>	○ <sup>3</sup>	-
2048 x 1080/25p <sup>5</sup>	-	○	○ <sup>3</sup>	○ <sup>3</sup>	-
2048 x 1080/30p <sup>1,5</sup>	-	○	○ <sup>3</sup>	○ <sup>3</sup>	-
2048 x 1080/48p <sup>1,5</sup>	-	-	○ <sup>4</sup>	○ <sup>4</sup>	-
2048 x 1080/50p <sup>5</sup>	-	-	○ <sup>4</sup>	○ <sup>4</sup>	-
2048 x 1080/60p <sup>1,5</sup>	-	-	○ <sup>4</sup>	○ <sup>4</sup>	-

<sup>1</sup> Compatible with 1/1.001 frame rates.

<sup>2</sup> PVM-A Series: 1080/25PsF, 30PsF, 2048/25PsF, 30PsF are displayed as 1080/25PsF, 30PsF, 2048/25PsF, 30PsF on the screen if the Payload ID is added to the video signal, or displayed as 1080/50i, 60i, 2048/50i, 60i if the ID is not added.

<sup>3</sup> 10-bit 4:4:4 Y/Cb/Cr and 4:4:4 RGB are supported.

<sup>4</sup> 10-bit 4:2:2 Y/Cb/Cr is supported.

<sup>5</sup> PVM-A250/PVM-A170 only support 1920 x 1080/30PsF, the dual link and 2048 signals.

## DVI Input Signals\*6

### PVM-A250 / PVM-A170

System	Dot clock (MHz)	HDMI/DVI fH (kHz)	fV (Hz)
640 x 480	25.175	31.5	60
1280 x 768	68.250	47.4	
1280 x 1024	108.000	64.0	
1360 x 768	85.500	47.7	
1440 x 900	88.750	55.5	
1680 x 1050	119.000	64.7	

\*6 A DVI-HDMI conversion cable is required. The sides of the displayed picture may be hidden depending on the input signal.

# PVM-A250/PVM-A170

## OLED Picture Monitors

### Lightweight and Slim – Easy to Carry

The PVM-A Series includes the PVM-A250 (25-inch) and PVM-A170 (17-inch) monitors, achieving an industry-leading lightweight and slimline body.\*1 The PVM-A250 weighs 6.1 kg and the PVM-A170 weighs just 4.2 kg, and both are approximately 40% slimmer than previous PVM-41 Series models. Furthermore, PVM-A Series monitors provide versatility for a wide range of user applications both in the studio and in the field: DC operation\*2, Wall-mount and yoke-mount holes, and an optional protection kit. These advantages allow the new PVM monitors to be used in a wider range of applications and reduce associated costs. These monitors are ideal for field monitoring and can be installed on a monitor wall or in an OB van. Now users can experience reliable, high-quality OLED monitoring anytime, anywhere.

\*1 Professional broadcast monitors incorporating SDI interface(s) and built-in AC power.

\*2 The PVM-A250 does not support DC operation.



### Wide Color Gamut and High-purity Deep Color Reproduction

TRIMASTER EL technology shows the largest color range of any Sony monitor ever offered. Color standards such as ITU-R BT.709, EBU, and SMPTE-C are displayed more accurately and, if desired, the OLED panel's native color gamut can be displayed. Micro-cavity structure uses an optical resonance effect in combination with accurate color filters to calibrate and stabilize RGB color accuracy. This combination is also effective in reducing ambient light reflection, and consequently deep color reproduction can be achieved without degradation, particularly in bright environments.

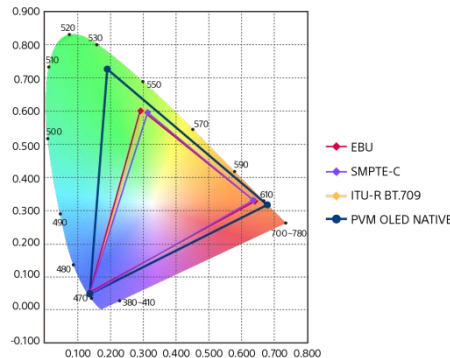

### Groundbreaking Picture Performance with TRIMASTER EL Technologies

24.5-inch and 16.5-inch Super Top Emission OLED display panels provide unparalleled black performance, a wide color gamut, and quick pixel response with virtually no motion blur. By combining TRIMASTER EL display panel (Full HD, 10-bit driver) and TRIMASTER EL processing technologies, the PVM Series of OLED monitors deliver exceptional picture quality never before seen in conventional picture monitors.

### TRIMASTER EL with Full HD and 10-bit RGB

The PVM-A250 and PVM-A170 OLED panel with Full HD resolution (1920 x 1080) and a 10-bit RGB driver, together with Super Top Emission OLED display panel, creates lifelike and smoother-than-ever gradation from dark to bright portions of a scene such as in a sunrise or sunset.



8-bit (256-levels) image



10-bit (1024-levels) image

\* Simulated images

### Superb Black Performance

Thanks to TRIMASTER EL system, deep blacks can be accurately displayed and the black portion of an image is not degraded.



Black performance image

\* Simulated images



# PVM-A250/PVM-A170

## OLED Picture Monitors

### 4K Production Features\*1

The PVM-A170 and PVM-A250 V2.0 fulfill the demand for affordable HD monitors in a 4K system. These units support the ITU-R BT.2020 color space and accept one of the Quad-Link 2SI 3G-SDI signals. To fully utilize its wide color gamut, each monitor offers DCI-P3 and S-GAMUT3/S-GAMUT3.cine settings, with proper EOTFs such as 2.6 gamma, S-Log3 (SDR), and S-Log2 (SDR).

\*1 Supported with V2.0

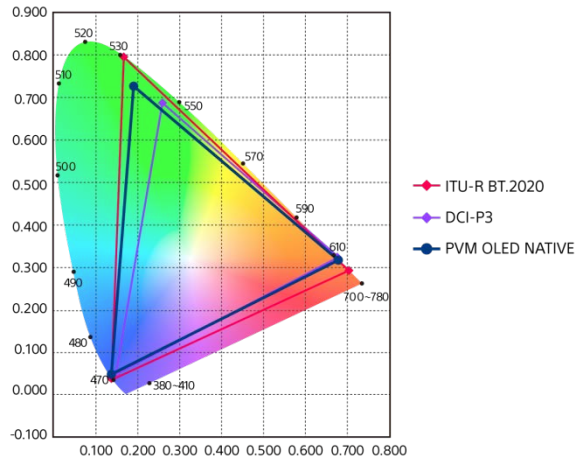

### Graphics Applications Features\*2

Each monitor accepts a computer signal through HDMI. To fully utilize its wide color gamut, the monitor also offers Adobe RGB and sRGB settings in color space, and D50 preset in color temperature.

\*2 Supported with V2.0

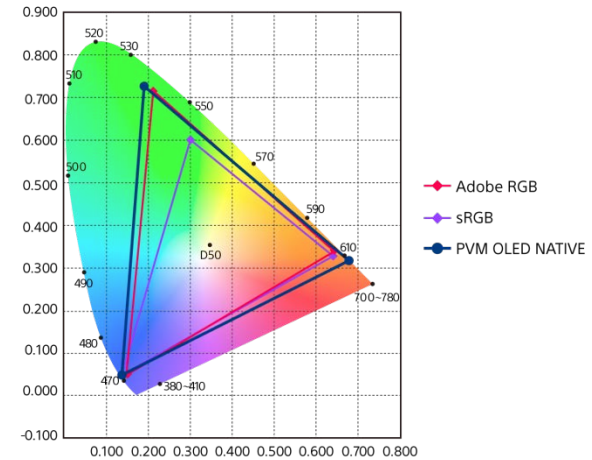

### False color function\*3

These monitors can display false color depends on the signal level from a camera. As the whole picture is changed, it is easy to see levels for over-exposure, under-exposure, and appropriate exposure. You can adjust these levels and turn the scale\*4 of false color on and off, as required.

\*3 Supported with V2.0

\*4 False color scale itself only supports a 0.45 OETF signal.

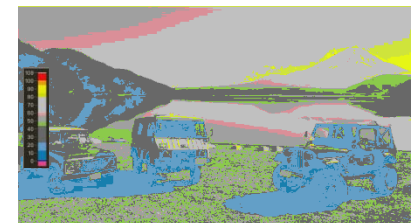

# PVM-A250/PVM-A170

OLED Picture Monitors

## Flexible Mounting For Picture Monitoring

The PVM-A250 and PVM-A170 monitors incorporate a lightweight, compact body. Their design offers flexibility, and can be adapted according to the application: a desktop unit with standard table feet, or used with an optional SU-561 stand, or without the stand for wall applications. These monitors support Wall mounting with a 100-mm pitch, and EIA 19-inch standard racks. This allows the monitors to be used for all types of application – desktop editing, office viewing, used on a studio monitor wall, or installed in OB vans.



PVM-A250 standard



PVM-A250 with optional SU-561



PVM-A250 without stand

## Optional Protection Kit

This accessory provides an AR-coated protection panel for the PVM-A250 and PVM-A170 monitors, along with corner bumpers to safeguard the monitor from scratches and impact. The benefit of this is significant when renting out these monitors – for example, panel damage is reduced and there is a far lower incidence of panel replacement and downtime during rental cycles.



PVM-A170 with protection kit image

## Yoke-mount and Wall-mount Capability

PVM-A250 and PVM-A170 monitors have screw holes on their side bezels for yoke mounting. This type of mounting is convenient when installing a monitor to a camera crane or monitor stand. There are also Wall-mount 100-mm pitch holes on each monitor's rear panel.



PVM-A250 with yoke-mount image (3rd vendor yoke mount is required)

## User-friendly Operability and UI

A rotary-type switch and seven function-assignable buttons allow users quick and intuitive operation. Operation buttons with LED indicators enable error-free operation, even in dark environments.\*1

\*1 LED lights can be switched on/off.



Front control panel

## Input Versatility

PVM-A Series monitors are equipped with built in standard input interfaces: 3G/HD/SD-SDI (x2), HDMI (HDCP) input (x1), and composite (x1). These monitors support dual-link HD-SDI to accept up to 1920 x 1080/50p, 60p signals.\*2 They also support 2048 x 1080/50p, 60p signals.\*2

\*2 Supported with V1.1.

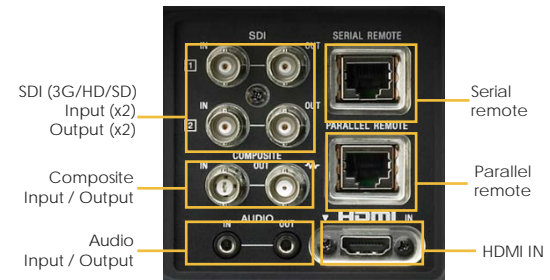

## Optimized Low-latency I/P Conversion

The I/P conversion system delivers automatically optimized signal processing according to input signals with low-latency (less than 0.5 field). This system helps users to edit and monitor for a live production.

# PVM-A250/PVM-A170

OLED Picture Monitors

## Waveform Monitor and Vector Scope Display

These enable users to monitor sources using the internal waveform and vector scope. These displays also provide some of the same evaluation tools as larger dedicated equipment. Both the waveform monitor and the vector scope offer zoom functions for very precise signal adjustment (from zero to 20% video level). In addition, the waveform monitor includes a line select feature, so users can adjust levels based on individual areas of the screen. Both displays have two-channel audio monitoring. In conjunction with the Picture & Picture function\*1 the waveform monitor and vector scope display can monitor two camera signals.

\*1 Supported with V1.1.



Waveform monitor

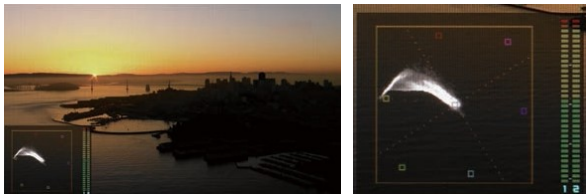

Vector scope

## Camera Focus Function

PVM-A Series monitors can control the aperture level of a video signal, and display images on screen with sharpened edges to help camera focus operation. Further to this, the sharpened edges can be displayed in user-selectable colors (white, red, green, blue, and yellow) for more precise focusing. As the PVM-941 has 940 x 540 pixels panel, this camera focus function can even be enhanced when combined with native scan mode.



Camera focus image

## Line-doubler Mode\*2 for Field Check

The PVM-A250 and PVM-A170 offer a line-doubler mode which is helpful when checking for line flicker.

\*2 Supported with V1.1.

## Auto White Adjustment\*3

The PVM-A250 and PVM-A170 monitors employ a software-based color temperature (white balance) calibration function, which is called Monitor\_AutoWhiteAdjustment. Combined with a PC and commercially available calibration tools\*4, this function enables simple adjustment of the monitor's white balance.

\*3 Supported with V1.1.

\*4 The Konica Minolta CA-210/CA-310/CS-200, DK-Technologies PM5639/06, X-Rite i1 Pro/i1 Pro2, Photo Research PR-655/670, Klein K-10, and JETI specbos 1211.

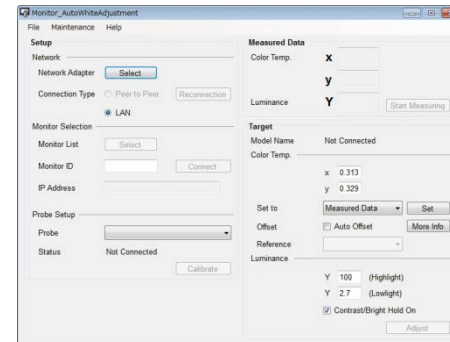

"Monitor\_AutoWhiteAdjustment" GUI image

# PVM-A250/PVM-A170

OLED Picture Monitors

## Enhanced Field Application Features

Sync-free side-by-side\*1 with low latency allows you to monitor two signals without synchronization. You can configure each picture as HD or SD with different frame rates, taking them from both SDI and HDMI. The monitor is ideal for field applications, with sync-free side-by-side, false color, and audio muting functions. You can monitor two pictures without synchronization. False color allows you to check the exposure level of a camera at a glance from a distance. Audio muting helps you to start shooting quickly.

\*1 Supported with V2.0. This function works with the false color function, camera focus function, and metadata on the main picture of the two pictures.



\* Simulated images

## Picture & Picture

The unique Picture & Picture function\*2 of the PVM-A250 and PVM-A170 allows simultaneous display of two input signals on the monitor's screen. This function helps with color adjustment and setting of camera frames.

\*2 Supported with V1.1. This function works when synchronous SDI signals are input.



Side-by-side



Wipe



Blending



Difference

## Camera/Lens Metadata Display Function and On-Screen tally\*3

PVM-A250 and PVM-A170 monitors can display the camera and lens metadata set of a camera system, according to the SMPTE RDD18\*4 document for Acquisition Metadata Sets for Video Camera Parameters. Further to this, these monitors also support a subset of Sony's private metadata.\*5 Each monitor is also equipped with a three-color (red, green, and yellow) on-screen tally function. The position of the tally display can be changed to either the upper or lower section of the screen.

\*3 Supported with V1.1.

\*4 Camera/Lens metadata is supported by F65, PMW-F55, PMW-F5, PXW-FS7M2 and PXW-FS7 as well as equipment capable of SMPTE RDD18.

\*5 Not all metadata is supported.



\* Simulated images



PXW-FS7M2

## Anamorphic Image Conversion\*6

Horizontally squeezed 3G/HD-SDI signals from an onset camera system are correctly displayed onscreen by LMD-A Series monitors\*3. These signals include two major systems: 16:9 1920 x 1080 (1280 x 720) signals and 17:9 2048 x 1080 signals.

\*6 Only 3G/HD-SDI and dual-link HD-SDI are supported.



Anamorphic OFF  
(X2.0)

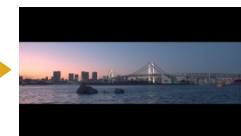

Native scan ON  
(X2.0 17:9)

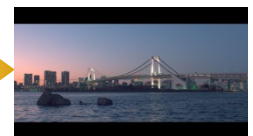

Native scan ON  
(2.39:1)

# PVM-A250/PVM-A170

OLED Picture Monitors

## 2K (2048 x 1080) Input and Image-slide\*1

PVM-A250 and PVM-A170 monitors are capable of 2K (2048 x 1080 resolution) input. The 2K signal is displayed in two ways – as a full 2K image scaled into a full-HD (1920 x 1080) screen, or as a 2K native display with an image-slide function.

\*1 Supported with V1.1.



## Grid Display\*2

This function displays arbitrary multiple vertical and horizontal lines to help when users check the composition of a picture.

\*2 Supported with V1.1.

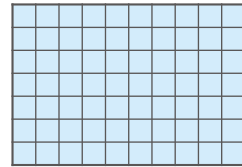

Vertical and horizontal lines

## Flip Function\*3

The Flip function turns the reversed image to a normal view, horizontally or vertically.

\*3 Supported with V1.1.

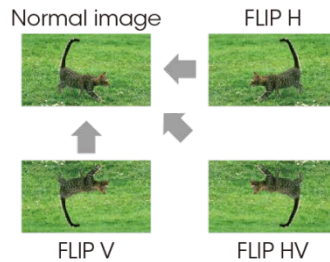

## Center Markers\*4

In addition to a standard Center Marker 1, Center Marker 2 is also available. This second marker enables easier checking of the center portion's focus.

\*4 Supported with V1.1.



Center marker 1



Center marker 2

## Flexible Area Marker\*5

Two flexible area markers can be freely set on the screen. This is useful for shopping channels; these require a unique screen layout to instantly differentiate between a product and its commercial data. The monitor allows you to set two flexible area markers anywhere on the screen.

\*5 Supported with V2.0.



Marker Preset Image 1

Marker Preset Image 2

Marker Preset Image 3



# PVM-A250/PVM-A170

## OLED Picture Monitors

### Short-cut to Function Key Configuration\*

By simply pressing the function key repeatedly, the user can take a short-cut to the settings menu screen.

### On-screen Tally\*

The on-screen tally can display in three colors. The position of the tally display can be changed to either the upper or lower section of the screen.

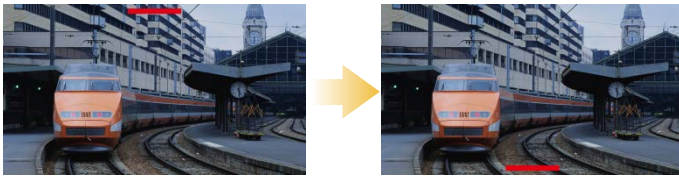

On-screen tally (upper)

On-screen tally (lower)

### Active Format Description (AFD) Function\*

PVM-A250 and PVM-A170 monitors read the ancillary data flag on an SDI, and up convert the SD image to display automatically on the full HD resolution screen. This is achieved by adjusting the resolution and aspect ratio.

\* Only SD-SDI signals are supported.

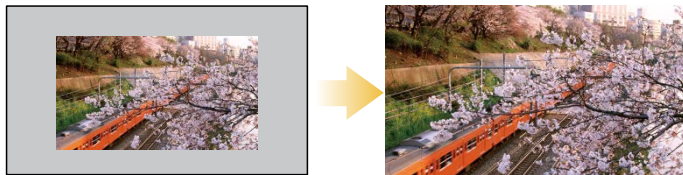

SD image

Up-converted image

### DC Low Power Indicator\*

The power indicator blinks when the DC power supply is low.

\* The PVM-A250 does not support a DC power supply.

### Multiple Monitors Upgrade Utility\*

Multiple PVM-A250 and PVM-A170 monitors on the same Ethernet network can be upgraded by simple operation.

### Power-on Setting\*

This function allows users to select setting data when the monitor starts up; this includes last memory, user preset, and factory preset settings. Users can set the monitor accurately and quickly. This function is very useful for rental equipment.

### User Presets\*

When multiple users share the same monitor, each user can memorize his/her setting data and retrieve this data whenever required. This frees the user from time-consuming and repetitive setting tasks.

### Password Lock for User Preset\*

When multiple users share the same monitor, each user can register his/her own password for color temperature and user preset data. This ensures the user correctly recalls previous user preset data, and keeps preset information safe from unauthorized use.

\* All functions on this page with an asterisk are supported with V1.1.



# LMD-A240/A220/A170

LCD Picture Monitors



LMD-A240



LMD-A220



LMD-A170

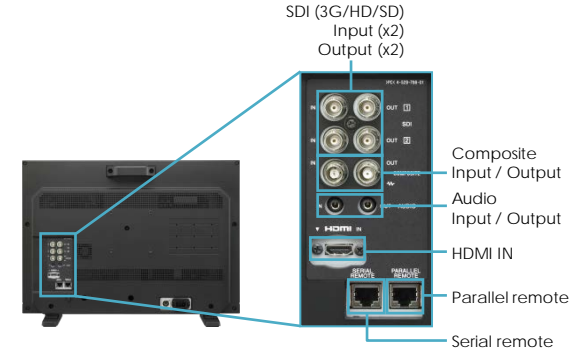

**Durable, Slim & Light-weight  
24"WUXGA/22"/17" FHD Premium  
LCD Monitors of Consistent Operability  
with PVM-A series**

## Main Features

- Lightweight and compact with lower power consumption
- 4K Production function\*1
- Shopping channels feature(Flexible Marker)\*1
- Enhanced field application features\*1
- Graphics applications features\*1
- Optimised low-latency I/P conversion
- In-Monitor Display (IMD) function
- Waveform monitor, vector scope and audio level meter display
- Yoke-mount and Wall-mount capability
- User-friendly operability and user interface
- Consistent design with PVM-A Series monitors
- Camera focus function
- Time code function
- On screen Tally
- Network control function
- Auto white adjustment\*2
- Picture & Picture function\*2
- 2K (2048 x 1080) input and image-slide\*2
- Camera/lens metadata display function and on-screen tally\*2
- Anamorphic image conversion and Active Format Description\*2
- Grid Display, two Center Markers and Flip functions\*2
- Power-on setting, DC Low Power indicator \*2
- Multiple monitors upgrade utility\*2
- Detachable handle (A220/A170 only)
- Optional protection kit (BKM-PL17) (A170 only)

\* 1 Supported with V2.0

\* 2 Supported with V1.1

	LMD-A240	LMD-A220	LMD-A170
<b>Picture Performance</b>			
Panel	a-Si TFT Active Matrix LCD		
Picture size (diagonal)	611.3 mm (24 1/8 inches)	546.1 mm (21 1/2 inches)	419.6 mm (16 5/8 inches)
Effective picture size (H x V)	518.4 x 324.0 mm (20 1/2 x 12 7/8 inches)	476.1 x 267.8 mm (18 3/4 x 10 5/8 inches)	365.8 x 205.7 mm (14 1/2 x 8 1/8 inches)
Resolution (H x V)	1920 x 1200 pixels (WUXGA)	1920 x 1080 pixels (Full HD)	
Aspect	16:10	16:09	
Colors	Approx. 1,073 million colors	Approx. 16.7 million colors	Approx. 1,073 million colors
Viewing angle (Panel specification)	89°/89°/89°/89° (typical) (up/down/left/right contrast > 10:1)		
<b>Input</b>			
Composite input	BNC (x1), 1.0 Vp-p ±3 dB sync negative		
SDI input	BNC (x2)		
HDMI input	HDMI (x1) (HDCP correspondence)		
Audio input	Stereo mini jack (x1), -5 dBu 47 kilohms or higher		
Parallel remote	RJ-45 Modular connector 8-pin (x1)		
Serial remote	RJ-45 Modular connector (x1) (Ethernet, 10BASE-T/100BASE-TX)		
DC input	XLR-type 4-pin (male) (x1) DC 12 V to 17 V (output impedance 0.05 Ω or less)		
<b>Output</b>			
Composite output	BNC (x1), loop-through, with 75 ohms automatic terminal function BNC (x2)		
SDI output	Output signal amplitude: 800 mVp-p ±10% Output impedance: 75 Ω unbalanced		
Audio monitor output	Stereo mini jack (x1)		
Speaker (built-in) output	1.0 W (monaural)		
Headphones output	Stereo mini jack (x1)		
<b>General</b>			
Power requirements	AC 100 V to 240 V, 0.5 A to 0.2 A, 50/60 Hz DC 12 V to 17 V, 3.6 A to 2.6 A	AC 100 V to 240 V, 0.5 A to 0.2 A, 50/60 Hz DC 12 V to 17 V, 3.4 A to 2.4 A	AC 100 V to 240 V, 0.5 A to 0.2 A, 50/60 Hz DC 12 V to 17 V, 3.6 A to 2.5 A
Power consumption	Approx. 51 W (max.) Approx. 45 W (average power consumption in the default sattu)	Approx. 47 W (max.) Approx. 43 W (average power consumption in the default sattu)	Approx. 49 W (max.) Approx. 42 W (average power consumption in the default sattu)
Operating temperature	0°C to 35°C (32°F to 95°F) Recommended: 20°C to 30°C (68°F to 86°F)		
Operating humidity	30% to 85% (no condensation)		
Storage / Transport temperature	-20°C to +60°C (-4°F to +140°F)		
Operating / Storage / Transport pressure	0% to 90%		
Operating / Storage / Transport pressure	700 hPa to 1060 hPa		
Mass	7.6 kg (16 lb 12 oz) (with monitor feet)	5.9 kg (13 lb)	4.9 kg (10 lb 13 oz) (with monitor feet)
Supplied accessories	AC power cord (1), AC plug holder (1), Before Using This Unit (1), CD-ROM (1)	AC power cord (1), AC plug holder (1), Handle (1) (including 4 screws), Before Using This Unit (1), CD-ROM (1)	

# LMD-A240/A220/A170

LCD Picture Monitors

## Dimensions

### LMD-A240

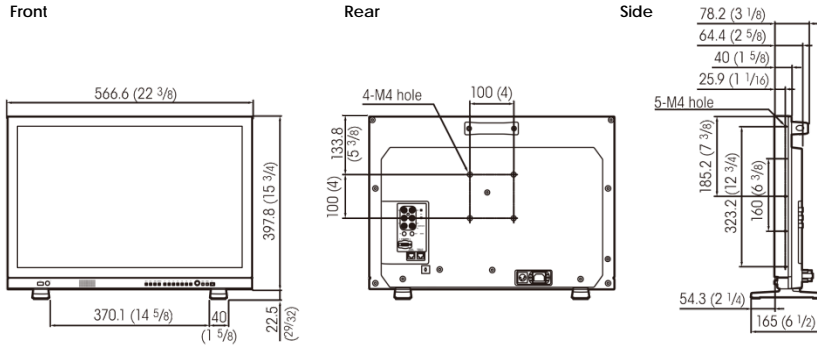

### LMD-A220

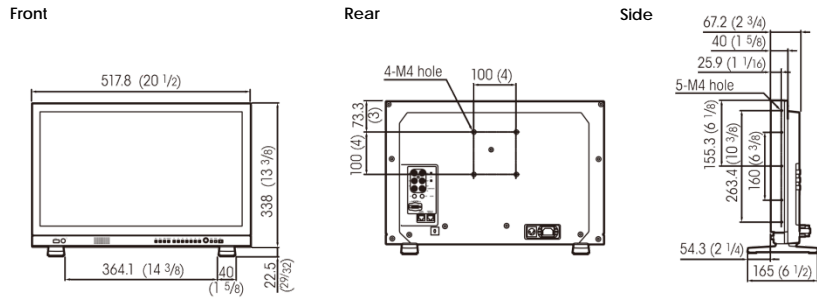

### LMD-A170

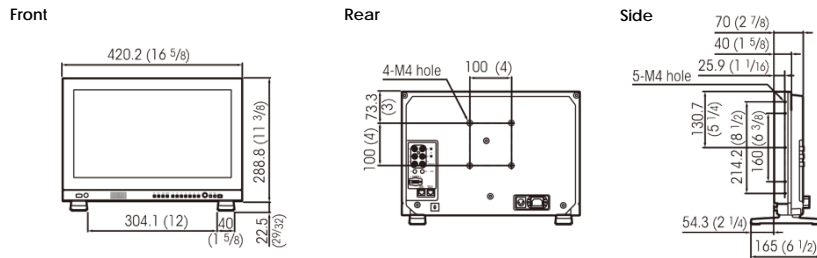

Unit: mm (inches)

## Options



**BKM-PL17**  
 Protection kit (for LMD-A170)



**MB-L17**  
 Mounting bracket (for LMD-A170)



**MB-L22**  
 Mounting bracket  
 (for PVM-A250, LMD-A220 and LMD-B240\*1)  
 \*1 Suffix/1 or later is required



**SU-561**  
 Monitor stand

# LMD-941W

## LCD Picture Monitors



Robust 9" FHD Premium LCD Monitor for Rackmount & On-set Shooting

### Main Features

- Full HD 1920x1080 pixels IPS LCD panel with LED backlight
- Two 3G/HD/SD-SDI inputs
- Camera focus function
- Intra-Field I/P mode
- Mobility and flexibility
- Wave form monitor and vector scope
- Timecode display
- Closed caption display
- color temperature
- Auto white adjustment
- Robust, light-weight, and compact body
- Mounting flexibility
- Optional ENG kit VF-510
- AC/DC operations
- 3 colors tally

Picture Performance	
Panel	a-Si TFT Active Matrix LCD
Picture size (diagonal)	228.0 mm (9 inches)
Effective picture size (H x V)	198.7 x 111.8 mm (77/8 x 41/2 inches)
Resolution (H x V)	1920 x 1080 pixels (Full HD)
Aspect	16:09
Colors	Approx. 16.7 million colors
Viewing angle (Panel specification)	89°/89°/89°/89° (typical) (up/down/left/right contrast > 10:1)
Input	
Composite input	BNC (x1), 1.0 Vp-p ±3 dB sync negative
SDI input	BNC (x2)
HDMI input	HDMI (x1) (HDCP correspondence)
Audio input	Stereo mini jack (x1), -5 dBu 47 kilohms or higher
Parallel remote	RJ-45 Modular connector 8-pin (x1)
Serial remote	RJ-45 Modular connector (x1) (Ethernet, 10BASE-T/100BASE-TX)
DC input	XLR-type 4-pin (male) (x1) DC12 V (output impedance 0.05 ohms or less)
Output	
Composite output	BNC (x1), loop-through, with 75 ohms automatic terminal function
SDI output	BNC (x1) Output signal amplitude: 800 mVp-p ±10% Output impedance: 75 Ω unbalanced
Audio monitor output	Stereo mini jack (x1)
Speaker (built-in) output	0.5 W (monaural)
Headphones output	Stereo mini jack (x1)
General	
Power requirements	AC 100 V to 240 V, 0.7 A to 0.4 A, 50/60 Hz DC 12 V, 2.5 A
Power consumption	Approx. 36 W (max.)
Operating temperature	0°C to 40°C (32°F to 104°F) Recommended: 20°C to 30°C (68°F to 86°F)
Operating humidity	30% to 85% (no condensation)
Storage / Transport temperature	-20°C to +60°C (-4°F to +140°F)
Storage / Transport humidity	0% to 90%
Operating / Storage / Transport pressure	700 hPa to 1060 hPa
Mass	2.0 kg (4 lb 6.5 oz) 2.6 kg (5 lb 12 oz) (when AC adaptor is installed)
Supplied accessories	AC power cord (1), AC adaptor (1), AC plug holder (1), Handle (1), Arm mount bracket (1), (including 4 screws), Operating Instructions (1), CD-ROM (1), Using the CD-ROM Manual (1)

### Dimensions

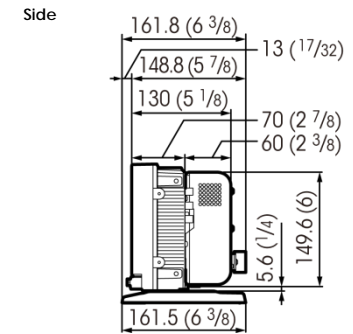
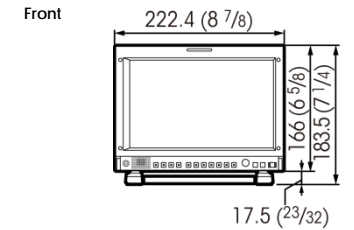

Unit: mm (inches)

### Options

**MB-531**  
Mounting Bracket



**MB-532**  
Mounting Panel



**VF-510**  
ENG Kit  
(Viewing Hood,  
Carrying Handle and  
Connector Protector)



# LMD-941W

## LCD Picture Monitors

### Easy-to-use control panel design

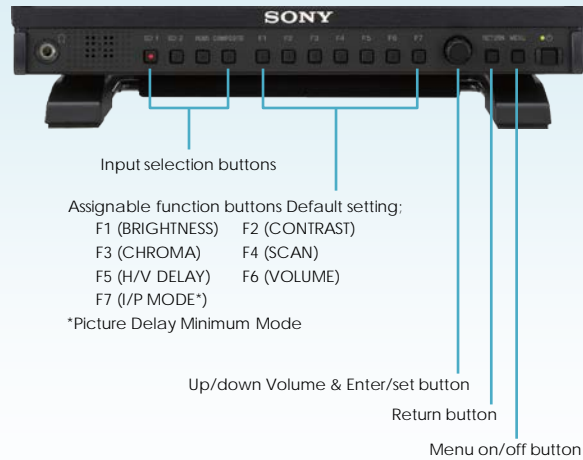

### Robust, light-weight, and compact body

Incorporating a light-weight and compact aluminum-diecast body with a detachable AR-coated protection panel, this model is flexible enough to change style according to user requirements.



AR-coated protection panel  
(This image is PVM-741)



LMD-941W installed in the optional MB-531 19" mounting bracket with MB-532 mounting panel

### Retractable Carrying Handle

A retractable carrying handle is provided as a supplied accessory, allowing users to carry these monitors anytime, anywhere.



LMD-941W with carrying handle

### Easy Mounting into A Camera System

With 3/8-inch and 1/4-inch screw holes on its base, the LMD-941W can be installed in a camera system. Also with the supplied arm-mount bracket fixed on the top, these monitors can be installed in a camera arm.



Rear and bottom

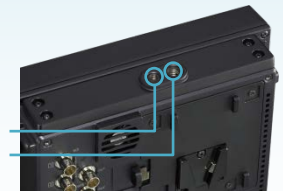

Arm-mount bracket is attached on the top

### ENG Kit VF-510

For use in ENG and EFP field, the optional VF-510 ENG Kit provides a viewing hood, carrying handle, and connector protector.



VF-510 ENG Kit

# LMD-A240/A220/A170/941W

LCD Picture Monitors

## Signal Formats

### LMD-A240/A220/A170

System	Signal standard				
	Analog composite	SDI			HDMI
		SD/HD	Dual link*5	3G	
575/50i (PAL)	○	○	-	-	○
480/60i (NTSC)*1	○	○	-	-	○
576/50p	-	-	-	-	○
480/60p*1	-	-	-	-	○
640 x 480/60p*1	-	-	-	-	○
1920 x 1080/24PsF*1+2	-	○	○*3	○*3	-
1920 x 1080/25PsF*2	-	○	○*3	○*3	-
1920 x 1080/30PsF*1+2	-	○*5	○*3	○*3	-
1920 x 1080/24p*1	-	○	○*3	○*3	○
1920 x 1080/25p	-	○	○*3	○*3	○
1920 x 1080/30p*1	-	○	○*3	○*3	○
1920 x 1080/50i	-	○	○*3	○*3	○
1920 x 1080/60i*1	-	○	○*3	○*3	○
1920 x 1080/50p	-	-	○*4	○*4	○
1920 x 1080/60p*1	-	-	○*4	○*4	○
1280 x 720/24p*1	-	○	-	-	-
1280 x 720/25p	-	○	-	-	-
1280 x 720/30p*1	-	○	-	-	-
1280 x 720/50p	-	○	-	○*3	○
1280 x 720/60p*1	-	○	-	○*3	○
2048 x 1080/24PsF*1+2+5	-	○	○*3	○*3	-
2048 x 1080/25PsF*2+5	-	○	○*3	○*3	-
2048 x 1080/30PsF*1+2+5	-	○	○*3	○*3	-
2048 x 1080/24p*1+5	-	○	○*3	○*3	-
2048 x 1080/25p*5	-	○	○*3	○*3	-
2048 x 1080/30p*1+5	-	○	○*3	○*3	-
2048 x 1080/48p*1+5	-	-	○*4	○*4	-
2048 x 1080/50p*5	-	-	○*4	○*4	-
2048 x 1080/60p*1+5	-	-	○*4	○*4	-

\*1 Compatible with 1/1.001 frame rates.

\*2 LMD-A Series: 1080/25PsF, 30PsF, 2048/25PsF, 30PsF are displayed as 1080/25PsF, 30PsF, 2048/25PsF, 30PsF on the screen if the Payload ID is added to the video signal, or displayed as 1080/50i, 60i, 2048/50i, 60i if the ID is not added.

\*3 10-bit 4:4:4 Y/Cb/Cr and 4:4:4 RGB are supported.

\*4 10-bit 4:2:2 Y/Cb/Cr is supported.

\*5 LMD-A240/LMD-A220/LMD-A170 only support 1920 x 1080/30PsF, the dual link and 2048 signals. Supported with V1.1.

## DVI Input Signals\*6

### LMD-A240/A220/A170

System	HDMI/DVI		
	Resolution	Dot clock (MHz)	fH (kHz)
640 × 480	25.175	31.5	60
1280 × 768	68.25	47.4	
1280 × 1024	108.000	64.0	
1360 × 768	85.500	47.7	
1440 × 900	88.750	55.5	
1680 × 1050	119.000	64.7	

\*6 A DVI-HDMI conversion cable is required.

The sides of the displayed picture may be hidden depending on the input signal.

## Signal Formats

### LMD-941W

System	Signal standard				
	Analog composite	SDI			HDMI
		SD/HD	Dual link	3G	
575/50i (PAL)	○	○	-	-	○
480/60i (NTSC)*7	○	○	-	-	○
576/50p	-	-	-	-	○
480/60p*7	-	-	-	-	○
640 x 480/60p*7	-	-	-	-	○
1920 x 1080/24PsF*7+8	-	○	-	○*9	-
1920 x 1080/25PsF*8	-	○	-	○*9	-
1920 x 1080/30PsF*7+8	-	○*11	-	○*9	-
1920 x 1080/24p*7	-	○	-	○*9	○
1920 x 1080/25p	-	○	-	○*9	○
1920 x 1080/30p*7	-	○	-	○*9	○
1920 x 1080/50i	-	○	-	○*9	○
1920 x 1080/60i*7	-	○	-	○*9	○
1920 x 1080/50p	-	-	-	○*10	○
1920 x 1080/60p*7	-	-	-	○*10	○
1280 x 720/24p*7	-	-	-	○*11	-
1280 x 720/25p	-	-	-	○*11	-
1280 x 720/30p*7	-	-	-	○*11	-
1280 x 720/50p	-	○	-	○*9	○
1280 x 720/60p*7	-	○	-	○*9	○

\*7 Compatible with 1/1.001 frame rates.

\*8 LMD-941W: 1080/24PsF, 25PsF, and 30PsF are displayed as 1080/48i, 50i, and 60i on the screen, respectively.

\*9 10-bit 4:4:4 Y/Cb/Cr and 4:4:4 RGB are supported.

\*10 10-bit 4:2:2 Y/Cb/Cr is supported.

\*11 3G-SDI 4:4:4 Y/Cb/Cr is supported.

# LMD-A240/A220/A170/941W

LCD Picture Monitors

## Flexible Mounting For Picture Monitoring

LMD-A Series monitors incorporate a lightweight, compact body. Their design offers flexibility, and can be adapted according to the application: a desktop unit with standard table feet, or used with an optional SU-561 stand, or without the stand for wall applications. These monitors support Wall mounting with a 100-mm pitch, and EIA 19-inch standard racks.\*1 This allows the monitors to be used for all types of application – desktop editing, office viewing, used on a studio monitor wall, or installed in OB vans.

\*1 The LMD-A240 cannot be 19" rack-mountable.



LMD-A240 standard



LMD-A240 with optional SU-561



LMD-A240 without stand

## Optional Protection Kit

This accessory provides an AR-coated protection panel for the LMD-A170 monitor, along with corner bumpers to safeguard the monitor from scratches and impact. The benefit of this is significant when renting out these monitors – for example, panel damage is reduced and there is a far lower incidence of panel replacement and downtime during rental cycles.



LMD-A170 with protection kit image

## Yoke-mount and Wall-mount Capability

LMD-A Series monitors have screw holes on their side bezels for yoke mounting. This type of mounting is convenient when installing a monitor to a camera crane or monitor stand. There are also Wall-mount 100-mm pitch holes on each monitor's rear panel



LMD-A240 with yoke-mount image (3rd vendor yoke mount is required)

	LMD-A240	LMD-A220	LMD-A170
Standard monitor feet	✓	✓	✓
Optional monitor stand	SU-561	SU-561	SU-561
Wall mounting (100 x 100 mm)	✓	✓	✓
Yoke mounting*2	✓	✓	✓
Rack mount (optional)	–	MB-L22	MB-L17
Protection kit (optional)	–	–	BKM-PL17

\*2 3rd vendor yoke mount is required.

## User-friendly Operability and UI

A rotary-type switch and seven function-assignable buttons allow users quick and intuitive operation. Operation buttons with LED indicators enable error-free operation, even in dark environments.\*3 LMD-A Series monitors offer the same functions and operability as PVM-A Series. This means that both types of monitor can be operated and controlled in the same way.

\*3 LED lights can be switched on/off.



Front control panel: Consistent design between the PVM-A and LMD-A Series.

## Input Versatility

LMD-A Series monitors are equipped with built-in standard input interfaces: 3G/HD/SD-SDI (x2), HDMI (HDCP) input (x1), and composite (x1). These monitors\*4 support dual-link HD-SDI to accept up to 1920 x 1080/50p, 60p signals.\*5 They also support 2048 x 1080/50p, 60p signals.\*5

\*4 The LMD-941W do not support dual-link HD-SDI and 2048 signals.

\*5 Supported with V1.1.

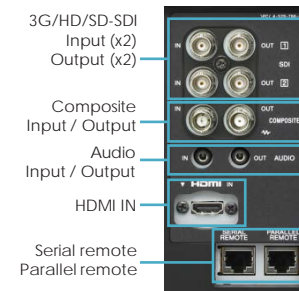

## Optimized Low-latency I/P Conversion

The I/P conversion system delivers automatically optimized signal processing according to input signals with low-latency (less than 0.5 field). This system helps users to edit and monitor for a live production.



# LMD-A240/A220/A170/941W

LCD Picture Monitors

## Waveform Monitor and Vector Scope Display\*1

These enable users to monitor sources using the internal waveform and vector scope. These displays also provide some of the same evaluation tools as larger dedicated equipment. Both the waveform monitor and the vector scope offer zoom functions for very precise signal adjustment (from zero to 20% video level). In addition, the waveform monitor includes a line select feature, so users can adjust levels based on individual areas of the screen. Both displays have two-channel audio monitoring. In conjunction with the Picture & Picture function\*1, the waveform monitor and vector scope display can monitor two camera signals.

\*1 Supported with V1.1.



Waveform monitor

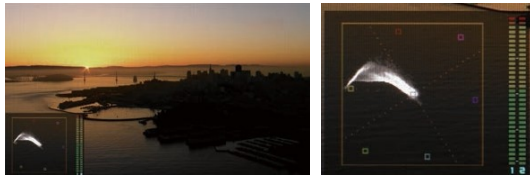

Vector scope

## Camera Focus Function

LMD-A Series monitors can control the aperture level of a video signal, and display images on screen with sharpened edges to help camera focus operation. Further to this, the sharpened edges can be displayed in user-selectable colors (white, red, green, blue, and yellow) for more precise focusing.



Camera focus image

## Time code and In-monitor Display (IMD) Function

With an external remote function via Ethernet, image source names and tally information can be displayed on screen. LMD-A Series monitors support the TSL system protocol. The IMD system can display European language text including umlaut and accent marks.



Time code and waveform monitor



Time code, on-screen tally, and 93% area marker



IMD on the LMD-A240 16:10 screen

## Auto White Adjustment\*2

LMD-A240, LMD-A220, LMD-A170, and LMD-941W monitors employ a software-based color temperature (white balance) calibration function, which is called Monitor\_AutoWhiteAdjustment. Combined with a PC and commercially available calibration tools\*3, this function enables simple adjustment of the monitor's white balance.

\*2 Supported with V1.1.

\*3 The Konica Minolta CA-210/CA-310/CS-200, DK-Technologies PM5639/06, X-Rite i1 Pro/i1 Pro2, Photo Research PR-655/670, Klein K-10, and JETI specbos 1211.

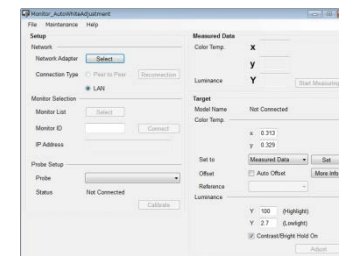

"Monitor\_AutoWhiteAdjustment" GUI image

# LMD-A240/A220/A170

LCD Picture Monitors

## Wide Color Gamut\*1

Thanks to Premium LCD technology\*2, Version 2.0 of these monitors supports ITU-R BT.2020, DCI-P3, S-GAMUT/S-GAMUT3/S-GAMUT3.cine, sRGB, and Adobe RGB. Color reproduction is very close to BVM/PVM Series reproduction in the wide color gamut. Combining the LMD-A Series Version 2.0 with BVM/PVM, you can build a lower cost monitoring system with higher satisfaction in color consistency.

\*1 Supported with V2.0.

\*2 LMD-A240 Serial Number 7100001 (for regions except China) & 7300001 (for China)  
LMD-A170 Serial Number 7100001 (for regions except China) & 7300001 (for China)

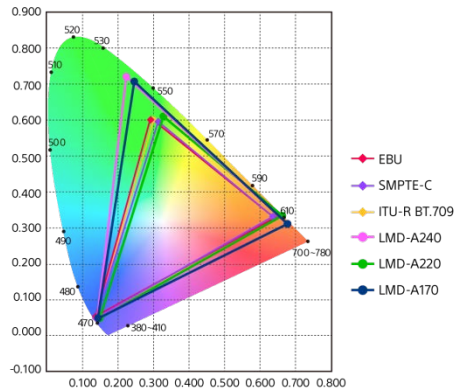

## False Color Function\*3

These monitors can display false color depends on the signal level from a camera. As the whole picture is changed, it is easy to see levels for over-exposure, under-exposure, and appropriate exposure. You can adjust these levels and turn the scale\*4 of false color on and off, as required.

\*3 Supported with V2.0

\*4 False color scale itself only supports a 0.45 OETF signal.

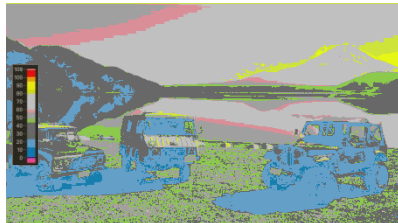

## 4K Production Features\*5

The LMD-A240, LMD-A220, and LMD-A170 V2.0 fulfil the demand for affordable HD monitors in a 4K system. These units support the ITU-R BT.2020 color space and accept one of the Quad-Link 2SI 3G-SDI signals. To fully utilize its wide color gamut, each monitor offers DCI-P3 and S-GAMUT/S-GAMUT3/S-GAMUT3.cine settings, with proper EOTFs such as 2.6 gamma, S-Log3 (SDR), and S-Log2 (SDR).

\*5 Supported with V2.0

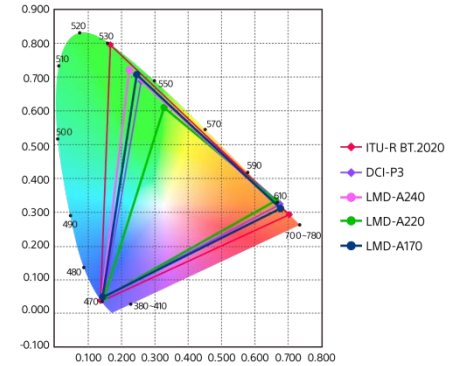

## Graphics Applications Features\*6

Each monitor accepts a computer signal through HDMI. To fully utilize its wide color gamut, the monitor also offers Adobe RGB and sRGB settings in color space, and D50 preset in color temperature.

\*6 Supported with V2.0

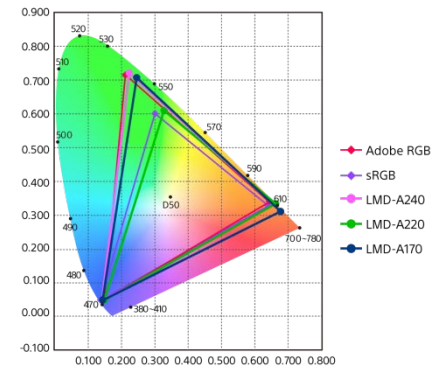

# LMD-A240/A220/A170

## LCD Picture Monitors

LMD-A Series monitors with camera-linkage functions\* provide the convenience of working efficiency both in the field and in the post-process. Their functions include camera metadata display and a Picture and Picture function. Also these monitors provide convenient features that save administrative operating costs, including User Preset, password lock, and a networking upgrade function.

The LMD-A Series offer common user interfaces (UIs), so that users can combine these monitors yet achieve the same functionality and operational familiarity across all display types.

### Enhanced field Application Features\*1

Sync-free side-by-side\*1 with low latency allows you to monitor two signals without synchronization. You can configure each picture as HD or SD with different frame rates, taking them from both SDI and HDMI. The monitor is ideal for field applications, with sync-free side-by-side, false color, and audio muting functions. You can monitor two pictures without synchronization. False color allows you to check the exposure level of a camera at a glance from a distance. Audio muting helps you to start shooting quickly.

\*1 Supported with V2.0. This function works with the false color function, camera focus function, and metadata on the main picture of the two pictures.



\* Simulated Images

### Picture & Picture

The unique Picture & Picture function\*2 of the PVM-A and LMD-A Series allows simultaneous display of two input signals on the monitor's screen. This function helps with color adjustment and setting of camera frames.

\*2 Supported with V1.1. This function works when synchronous SDI signals are input

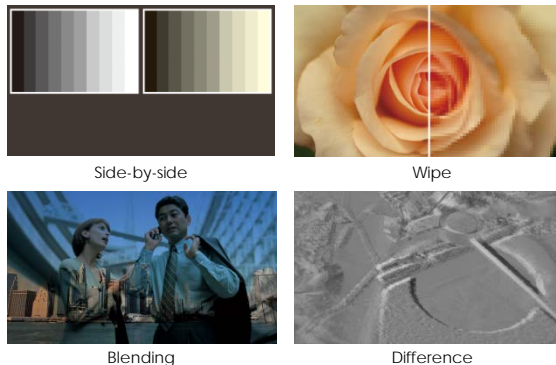

### Camera/Lens Metadata Display Function And On-Screen Tally\*3

LMD-A Series monitors can display the camera and lens metadata set of a camera system, according to the SMPTE RDD18\*4 document for Acquisition Metadata Sets for Video Camera Parameters. Further to this, these monitors also support a subset of Sony's private metadata. \*5 Each monitor is also equipped with a three-color (red, green, and yellow) on-screen tally function. The position of the tally display can be changed to either the upper or lower section of the screen.

\*3 Supported with V1.1.

\*4 Camera/Lens metadata is supported by F65, PMW-F55, PMW-F5, PXW-FS7M2 and PXW-FS7 as well as equipment capable of SMPTE RDD18.

\*5 Not all metadata is supported.



\* Simulated Images



PXW-FS7M2

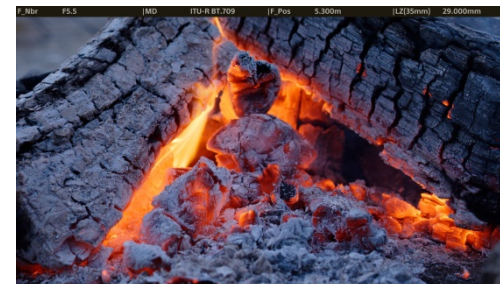

\* Simulated Images

# LMD-A240/A220/A170

LCD Picture Monitors

## 2K (2048 x 1080) Input and Image-slide\*1

LMD-A Series monitors are capable of 2K (2048 x 1080 resolution) input. The 2K signal is displayed in two ways – as a full 2K image scaled into a full-HD (1920 x 1080) screen, or as a 2K native display with an image-slide function.

\*1 Supported with V1.1



## Anamorphic Image Conversion\*2

Horizontally squeezed 3G/HD-SDI signals from an onset camera system are correctly displayed onscreen by LMD-A Series monitors\*3. These signals include two major systems: 16:9 1920 x 1080 (1280 x 720) signals and 17:9 2048 x 1080 signals.

\*2 Supported with V1.1

\*3 Only 3G/HD-SDI and dual-link HD-SDI are supported.



## Grid Display\*4

This function displays arbitrary multiple vertical and horizontal lines to help when users check the composition of a picture.

\*4 Supported with V1.1

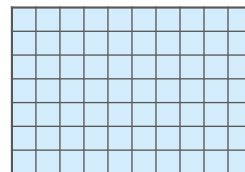

Vertical and horizontal lines

## Flexible area marker \*5

Two flexible area markers can be freely set on the screen. This is useful for shopping channels; these require a unique screen layout to instantly differentiate between a product and its commercial data. The monitor allows you to set two flexible area markers anywhere on the screen.

\*5 Supported with V2.0.



## Center Markers\*6

In addition to a standard Center Marker 1, Center Marker 2 is also available. This second marker enables easier checking of the center portion's focus.

\*6 Supported with V1.1



Center marker 1



Center marker 2



# LMD-A240/A220/A170

LCD Picture Monitors

## Flip Function\*

The Flip function turns the reversed image to a normal view, horizontally or vertically.

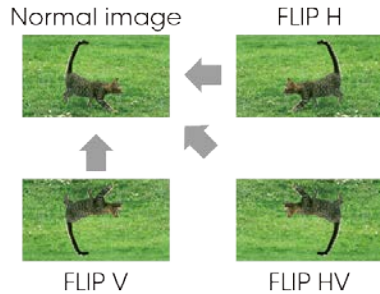

## Multiple Monitors Upgrade Utility\*

Multiple LMD-A Series monitors on the same Ethernet network can be upgraded by simple operation.

## Power-on Setting\*

This function allows users to select setting data when the monitor starts up; this includes last memory, user preset, and factory preset settings. Users can set the monitor accurately and quickly. This function is very useful for rental equipment.

## User Presets\*

When multiple users share the same monitor, each user can memorize his/her setting data and retrieve this data whenever required. This frees the user from time-consuming and repetitive setting tasks.

## DC Low Power Indicator \*

The power indicator blinks when the DC power supply is low.

## Password Lock for User Preset\*

When multiple users share the same monitor, each user can register his/her own password for color temperature and user preset data. This ensures the user correctly recalls previous user preset data, and keeps preset information safe from unauthorized use.

## Short-cut to Function Key Configuration\*

By simply pressing the function key repeatedly, the user can take a short-cut to the settings menu screen.

## On-screen Tally\*

The on-screen tally can display in three colors. The position of the tally display can be changed to either the upper or lower section of the screen.



On-screen tally (upper)



On-screen tally (lower)

## Active Format Description (AFD) Function\*

LMD-A Series monitors read the ancillary data flag on an SDI, and upconvert the SD image to display automatically on the full HD resolution screen. This is achieved by adjusting the resolution and aspect ratio. (Only SD-SDI signals are supported.)

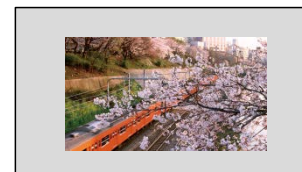

SD image



Up-converted image

\* All functions on this page with an asterisk are supported with V1.1.

# LMD-B240/LMD-B170

LCD Picture Monitors



17"/24" cost-effective, lightweight  
Basic grade Full HD LCD monitor for  
versatile use

## Main Features

- Industry standard 17"/24" screen size and Full HD resolution
- Lightweight and compact with lower power consumption
- Simple all-in-one design style
- Sync-Free Side by Side function with low latency\*1
- Audio muting\*1
- LMD-A type stands\*2
- Rack mounting MB-L22\*3
- Front stereo speakers and Natural ventilation system
- Optimized low-latency I/P conversion
- Video input / Computer input versatility
- Waveform monitor, vector scope and audio level meter display
- User-friendly operability and user interface consistent with PVM/LMD-A Series monitors.
- Camera focus function
- Time code function
- On-screen tally
- User reset, Key inhibit, User Short-cut to function key configuration
- Side by side function
- Flip function
- AC/DC operation with DC Low Power indicator
- Wall-mount capability

\*1 These features are supported from serial No.7000971 or later (Serial No.7200581 or later in China) of LMD-B170.

\*2 Only LMD-B240.

\*3 LMD-B240 may not be installed to a 19 inches rack with deep front columns or a front door. Suffix /1 or later is required.

	LMD-B240	LMD-B170
<b>Picture Performance</b>		
Panel	a-Si TFT Active Matrix LCD	
Picture size (diagonal)	604.7mm (23 7/8 inches)	438.2 mm (17 3/8 inches)
Effective picture size (H x V)	527.0 x 296.5 mm (20 3/4 x 11 3/4 inches)	381.9 x 214.8 mm (15 1/8 x 8 1/2 inches)
Resolution (H x V)	1920 x 1080 pixels (Full HD)	
Aspect	16:9	
Colors	Approx. 16.7 million colors	
Viewing angle (Panel specification)	89°/89°/89°/89° (typical) (up/down/left/right contrast > 10:1)	80°/60°/80°/80° (typical) (up/down/left/right contrast > 10:1)
<b>Input</b>		
Composite input	BNC (x1), 1.0 Vp-p ±3 dB, sync negative	
SDI input	BNC (x2)	
HDMI input	HDMI (x1) (HDCP correspondence)	
Audio input	Stereo mini jack (x1), -5 dBu 47 kΩ or higher	
Parallel remote	RJ-45 Modular connector 8-pin (x1) (Pin-assignable)	
DC input	XLR-type 4-pin (male) (x1) DC12 V to 17V (output impedance 0.05 Ω or less)	
<b>Output</b>		
Composite output	BNC (x1), loop-through, with 75 Ω automatic terminal function	
SDI output	BNC (x1)*4 Output signal amplitude: 800 mVp-p ±10% Output impedance: 75 Ω unbalanced	
Audio monitor output	Stereo mini jack (x1)	
Speaker (built-in) output	2.0 W + 2.0 W (Stereo)	
Headphones output	Stereo mini jack (x1)	
<b>General</b>		
Power requirements	AC 100 V to 240 V, 0.5 A to 0.3 A, 50/60 Hz DC 12 V to 17 V, 3.2 A to 2.0 A	AC 100 V to 240 V, 0.4 A to 0.3 A, 50/60 Hz DC 12 V to 17 V, 2.7 A to 1.9 A
Power consumption	Approx. 41 W (max.) Approx. 29 W (average power consumption in the default status)	Approx. 38 W (max.) Approx. 28 W (average power consumption in the default status)
Operating temperature	0°C to 35°C (32°F to 95°F) Recommended: 20°C to 30°C (68°F to 86°F)	
Operating humidity	30% to 85% (no condensation)	
Storage / Transport temperature	-20°C to +60°C (-4°F to +140°F)	
Storage / Transport humidity	0% to 90%	
Operating / Storage / Transport pressure	700 hPa to 1060 hPa	
Dimensions (W x H x D)*5	563.0 x 375.3 x 69.0 mm (22 1/4 x 14 7/8 x 2 3/4 inches) (without monitor feet) 563.0 x 397.6 x 164.9 mm (22 1/4 x 15 3/4 x 6 1/2 inches) (with monitor feet)	423.2 x 303.8 x 68.0 mm (16 3/4 x 12 x 2 3/4 inches) (without monitor feet) 423.2 x 346.5 x 264.4 mm (16 3/4 x 13 3/4 x 10 1/2 inches) (with monitor feet)
Mass	6.3 kg (13 lb 14.2 oz) (without monitor feet) 6.4 kg (14 lb 1.8 oz) (with monitor feet)	4.1 kg (9 lb 0.6 oz) (without monitor feet) 5.9 kg (13 lb 0.1 oz) (with monitor feet)
Supplied accessories	AC power cord (1), AC plug holder (1), Before Using This Unit (1), CD-ROM (1)	

\*4 Output from SDI 1 only.

\*5 The values for mass and dimensions are approximate.

## Input / Output

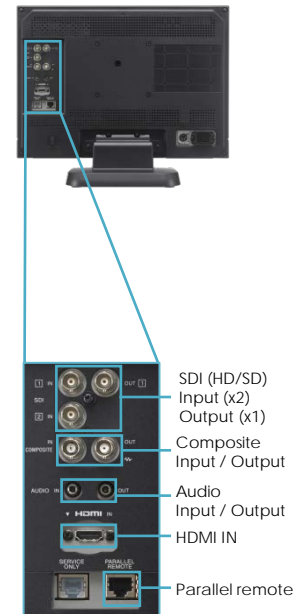



# LMD-B240/LMD-B170

LCD Picture Monitors

## Dimensions

### LMD-B240

Front

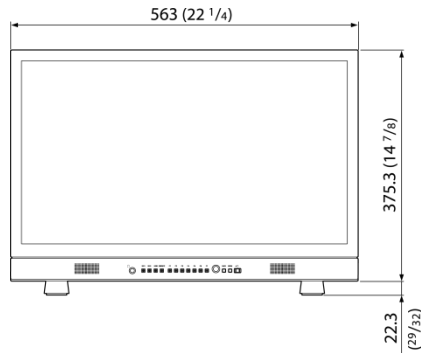

Rear

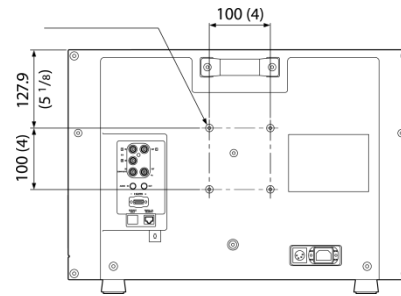

Side

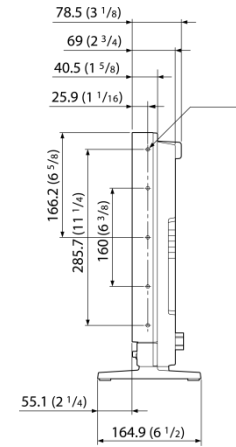

### LMD-B170

Front

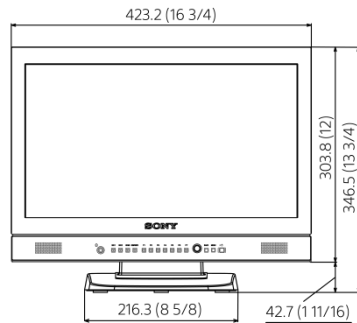

Rear

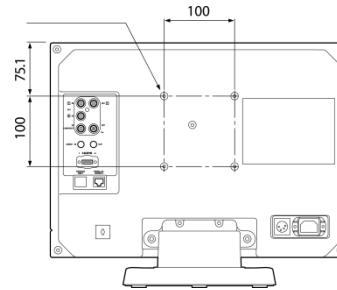

Side

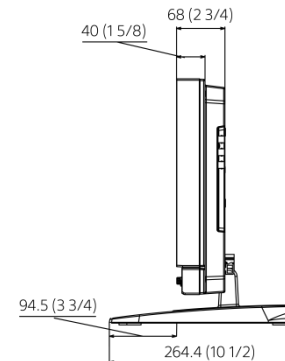

Unit: mm (inches)

# LMD-B240/LMD-B170

LCD Picture Monitors

## Industry Standard 17"/24" Screen size And Full HD Resolution

Industry standard 17"/24" screen are a most user-friendly size to be suitable from a desk-top use to a wall-mounting use, an arm-mounting use and an outfield shooting. The Full HD(1920x1080) resolution is approximately 200% higher resolution than Wide-XGA(1366x768 or 1280x768). FHD is today's minimum requirement for a video production and versatile monitoring purposes of many industries to get a sharp focus and make a pixel to pixel check of a Full HD video with no scaling. The LMD-B170/LMD-B240 satisfies both requirements with an excellent cost-performance ratio.

## Unique SDI and HDMI Sync-Free Side By Side Configurations

The LMD-B170 and LMD-B240 offer unique SDI and HDMI sync-free side-by-side\*1 configurations, allowing the same monitor to display HD, SD, different frame rates, interlace, PsF, and progressive pictures.

\*1 This feature is supported from serial No.7000971 or later (Serial No.7200581 or later in China) of LMD-B170.



## Lightweight And Compact With Lower Power Consumption

LMD-B170 and LMD-B240 monitors incorporate a lightweight, compact body. These monitors inherit their all-in-one design style from the PVM/LMD-A Series. Each unit has the mandatory interfaces such as SDI, HDMI, and composite video with stereo analog audio. You can monitor both embedded SDI audio signals and analog audio signals on the screen's audio level meters. In addition, the LMD-B170 has a supplied stand with a tilt function.



LMD-B170

## Optimized Low-latency I/P Conversion

The I/P conversion system delivers automatically optimized signal processing according to input signals with low-latency (less than 0.5 field). This system helps users to edit and monitor for a live production.

## Front Stereo Speakers And Natural Ventilation System

2W+2W front stereo speakers are more powerful than a monaural speaker or a rear speaker system and you can get a good stereophonic effect from them. You can select audio sources from either embedded audio or analog audio. There is no cooling fan inside and it is suitable for a video shooting and critical audio operation.

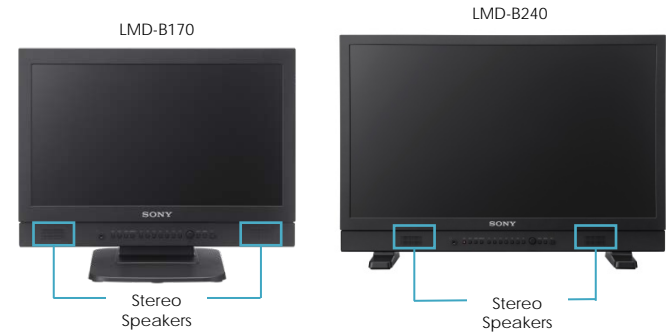

## Video Input / Computer input Versatility

Both monitors are equipped with built-in standard input interfaces: HD/SD-SDI (x2), HDMI (HDCP) input (x1) and composite (x1). Multiple computer signals can be received via an HDMI/DVI\*2 interface; the resolution range is from 640 x 480 to 1680 x 1050 pixels.

\*2 HDMI-DVI conversion cable required.

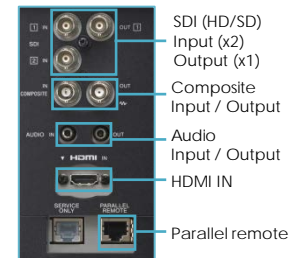

# LMD-B240/LMD-B170

LCD Picture Monitors

## User-friendly Operability and User Interface

A rotary-type switch and seven function-assignable buttons allow quick and intuitive operation. Operation buttons with LED indicators enable error-free operation, even in dark environments.\*1

LMD-B170 and LMD-B240 monitors offer the same functions and operability as the PVM-A/ LMD-A Series. This means that both types of monitor can be operated and controlled in the same way.



\*1 LED lights can be switched on/off.



Front control panel: Consistent design between the PVM-A and LMD-A Series.

## Waveform monitor, vector scope and audio level meter display\*2

An input signal's waveform and vector scope with an SDI embedded 2-channel audio level meter can be displayed on screen. The waveform of a specified line can also be displayed. In conjunction with the Picture & Picture function\*2, the waveform monitor and vector scope display can monitor two camera signals. In addition, an audio level meter can display the embedded audio signal from the SDI or HDMI input. It can display on screen the ch1 to ch8 or ch9 to ch16.

\*2 Supported with V1.1.



Waveform monitor

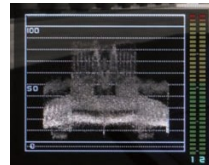

Vector scope

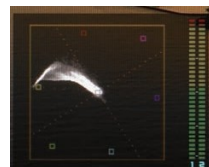

## Camera Focus Function

The LMD-B series monitors can control the aperture level of a video signal, and display images on screen with sharpened edges to help camera focus operation. Further to this, the sharpened edges can be displayed in user-selectable colors (white, red, green, blue, and yellow) for more precise focusing.



Camera focus image

## Time code

Tally information can be displayed on screen.



Time code and waveform monitor



Time code, on-screen tally, and 93% area marker

## On-screen Tally

The on-screen tally can display in three colors.



On-screen tally

## User reset, Key inhibit, User Short-cut to function key configuration

When multiple users share the same monitor, you need to reset it in a quick operation. User reset function quickly returns the unit to the default settings. Key inhibit protects the required settings of it from any inadvertent operations. For improving speed of the function key configuration, the user can take a short-cut to the settings menu screen by simply holding down one of the Function keys.

# LMD-B240/LMD-B170

LCD Picture Monitors

## Side-by side

The two picture images\*1 are downscaled using a digital filter and displayed side-by-side. This feature is convenient when making white balance adjustments or determining shooting angles between two cameras. You can use this with the waveform monitor or vector. You can use this with the waveform monitor or vector.



\*1 Two signals must be synchronized.

## Flip Function

The Flip function turns the reversed image to a normal view, horizontally or vertically.

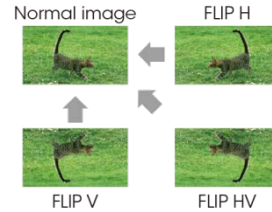

## Wall-Mount Capability

There are also wall-mount 100 mm pitch holes on each monitor's rear panel, and a built-in AC circuit allows you to install the unit easily and flexibly. It can also be rack mounted with the MB-L22\*2 Rack Mount Bracket.

\*2 LMD-B240 may not be installed to a 19 inches rack with deep front columns or a front door. Suffix / 1 or later is required.

## Audio Muting

Audio muting\*3 is also available for a quick -start shooting.

\*3 This feature is supported from serial No.7000971 or later (Serial No.7200581 or later in China) of LMD-B170.

## DVI Input Signals\* 4

System	HDMI/DVI		
	Resolution	Dot clock (MHz)	fH (kHz)
640 × 480	25.175	31.5	60
1280 × 768	68.25	47.4	
1280 × 1024	108.000	64.0	
1360 × 768	85.500	47.7	
1440 × 900	88.750	55.5	
1680 × 1050	119.000	64.7	

\*4 A DVI-HDMI conversion cable is required.

The sides of the displayed picture may be hidden depending on the input signal.

## Signal Formats

System	Signal standard				
	Analog composite	SDI			HDMI
		SD/HD	Dual link	3G	
575/50i (PAL)	O	O	-	-	O
480/60i (NTSC)*5	O	O	-	-	O
576/50p	-	-	-	-	O
480/60p*5	-	-	-	-	O
640 x 480/60p*5	-	-	-	-	O
1920 x 1080/24PsF*5*6	-	O	-	-	-
1920 x 1080/25PsF*6	-	O	-	-	-
1920 x 1080/30PsF*5*6	-	O	-	-	-
1920 x 1080/24p*5	-	O	-	-	O
1920 x 1080/25p	-	O	-	-	O
1920 x 1080/30p*5	-	O	-	-	O
1920 x 1080/50i	-	O	-	-	O
1920 x 1080/60i*5	-	O	-	-	O
1920 x 1080/50p	-	-	-	-	O
1920 x 1080/60p*5	-	-	-	-	O
1280 x 720/24p*5	-	O	-	-	-
1280 x 720/25p	-	O	-	-	-
1280 x 720/30p*5	-	O	-	-	-
1280 x 720/50p	-	O	-	-	O
1280 x 720/60p*5	-	O	-	-	O
2048 x 1080/24PsF	-	O	-	-	-
2048 x 1080/25PsF	-	-	-	-	-
2048 x 1080/30PsF	-	-	-	-	-
2048 x 1080/24p	-	-	-	-	-
2048 x 1080/25p	-	-	-	-	-
2048 x 1080/30p	-	-	-	-	-
2048 x 1080/48p	-	-	-	-	-
2048 x 1080/50p	-	-	-	-	-
2048 x 1080/60p	-	-	-	-	-

\*5 Compatible with 1/1.001 frame rates.

\*6 1080/25PsF, 30PsF are displayed as 1080/25PsF, 30PsF on the screen if the Payload ID is added to the video signal, or displayed as 1080/50i, 60i if the ID is not added.

# LMD-2110W

LCD Monitors



Reliable 21" FHD LCD Professional Monitors for Basic Monitoring

## Main Features

- High purity color filters
- Excellent brightness and contrast
- 109% peak white and 10-bit signal processing
- Color temperature/gamma selection
- Marker settings
- Selectable scan size for video input and aspect ratio
- Three-color tally
- Audio monitoring
- Protected controls
- Mountable in an EIA 19-inch Standard Rack
- Wall mounting
- Parallel remote control
- Standard inputs and expandability

Picture Performance	
Panel	a-Si TFT Active Matrix LCD
Picture size (diagonal)	547.0 mm (21 5/8 inches)
Effective picture size (H x V)	477.0 x 268.0 mm (18 7/8 x 10 5/8 inches)
Resolution (H x V)	1920 x 1080 pixels (Full HD)
Aspect	16:09
Colors	Approx. 16.7 million colors
Viewing angle	170°/160° (typical) (horizontal/vertical contrast > 10:1)
Input	
Composite	BNC (x1), 1.0 Vp-p ±3 dB sync negative
Y/C	Mini DIN 4-pin (x1) Y: 1.0 Vp-p ±3 dB sync negative C: 0.286 Vp-p ±3 dB (NTSC burst signal level), 0.3 Vp-p ±3 dB (PAL burst signal level)
RGB, Component	BNC (x3) RGB: 0.7 Vp-p ±3 dB (Sync On Green, 0.3 Vp-p sync negative) Component: 0.7 Vp-p ±3 dB (75% chrominance standard color bar signal)
HDMI	HDMI (x1) (HDCP correspondence)
Audio	Phono jack (x2), -5 dBu 47 kilohms or higher OPTION AUDIO IN: Phono jack (x1), -5 dBu 47 kilohms or higher
External sync	BNC (x1), 0.3 Vp-p to 4 Vp-p negative polarity binary
Option in connector	D-sub 9-pin (x1), female
Parallel remote	Modular connector 8-pin (x1) (pin-assignable)
Output	
Composite	BNC (x1), loop-through, with 75 ohms automatic termination
Y/C	Mini DIN 4-pin (x1), loop-through, with 75 ohms automatic termination
RGB, Component	BNC (x3), loop-through, with 75 ohms automatic termination
External sync	BNC (x1), loop-through, with 75 ohms automatic termination
Audio monitor out	Phono jack (x2), loop-through
Speaker (built-in)	0.5 W (mono)
General	
Power requirements	AC 100 V to 240 V, 50/60 Hz, 1.3 A to 0.6 A
Power consumption	Approx. 69 W (max.)
Operating temperature	0°C to 35°C (32°F to 95°F) Recommended: 20°C to 30°C (68°F to 86°F)
Operating humidity	30% to 85% (no condensation)
Storage and transport temperature	-20°C to +60°C (-4°F to +140°F)
Storage and transport humidity	0% to 90%
Operating, storage, and transport pressure	700 hPa to 1060 hPa
Dimensions (W x H x D) (with stand)	515.0 x 403.0 x 264.0 mm (20 3/8 x 15 7/8 x 10 1/2 inches)
Dimensions (W x H x D) (without stand)	515.0 x 355.0 x 86.0 mm (20 3/8 x 14 x 3 1/2 inches)
Mass	8.6 kg (18 lb 15 oz)
Mass (without stand)	6.9 kg (14 lb 19 oz)
Supplied accessories	AC power cord (1), AC plug holder (1), Operating instructions (1), CD-ROM (1), Using the CD-ROM Manual (1)

## Dimensions

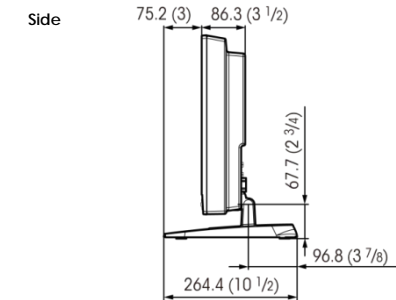
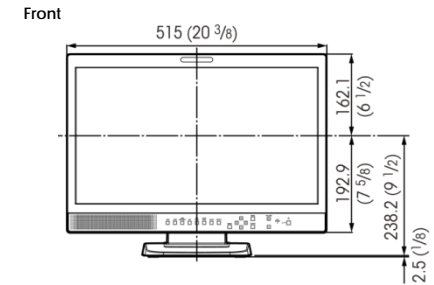

## Options



**MB-529**  
Mounting Bracket



**BKM-341HS**  
HD/SD-SDI Input Adaptor

# LMD-2110W

LCD Monitors

## High purity color filters

Equipped with high-purity RGB color filters, LMD-2110W monitor achieves color reproduction with stunning depth and saturation.

## Excellent brightness and contrast

LMD-2110W monitor provides high-brightness, high contrast images thanks to their wide aperture LCD panels. In addition, the use of precisely manufactured RGB color filters allows these monitors to reproduce colors with stunning depth and saturation – creating highly natural images.

## 109% peak white and 10-bit signal processing

Incorporating high-purity RGB color filters and 10-bit signal processing engine, LMD-2110W monitor offers stunning 109% peak white reproduction without clipping and a smooth gray scale.

## Color temperature/gamma selection

With LMD-2110W monitor, users can select from high, low, or preset color temperatures. A variety of gamma modes can also be selected.



Incorrect gamma image

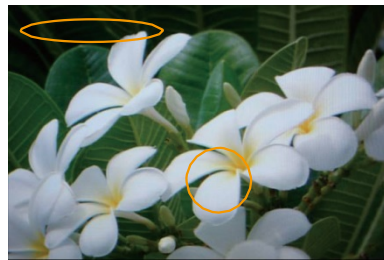

Correct gamma image

\* Simulated images

## Operational Convenience

### Marker settings

LMD-2110W monitor can display a center marker, aspect markers, and safety area markers in different sizes.\*<sup>1</sup> The brightness of these markers can be set at different levels. These flexible marker settings make these monitors extremely convenient display devices for a variety of shooting scenarios.

\*<sup>1</sup> 80%, 85%, 88%, 90%, or 93% can be selected.

### Selectable scan size for video input and aspect ratio

The scan size can be selected: Normal (0%), Over (5%), and Full scan. The aspect ratio can be switched between 16:9 and 4:3 according to the input signal.

### Three-color tally

LMD-2110W is equipped with a tally lamp that can be lit via a parallel remote connector. The status of the signal displayed on the monitor can be identified by the tally color: red, green, or amber.

### Audio monitoring

LMD-2110W is equipped with a monaural speaker (0.5 W), which enables the user to monitor audio.

### Key inhibit

With LMD-2110W monitor, the key-inhibit function helps prevent inadvertent operation from the control panel.



# LMD-2110W

LCD Monitors

## Mounting Flexibility and Remote Access

### Mountable in an EIA 19-inch Standard Rack

LMD-2110W can be mounted in a EIA 19-inch standard rack using optional mounting brackets. The 9U-high LMD-2110W uses MB-529 Mounting Bracket.

### Wall mounting

Wall standard mounting holes (100 x 100 mm pitch) are provided on LMD-2110W monitor to enable wall or ceiling installation.

### Parallel remote control

These basic-level type LMD-2110W can be controlled remotely via their parallel remote connectors. In the remote menu, there are 16 functions for the LMD-2110W, of which seven can be allocated to the remote connector.

## Input Versatility

### Standard inputs and expandability

LMD-2110W is equipped with a full range of analog SD inputs including analog composite NTSC and PAL, Y/C (S-Video), and 525i/625i component and RGB. These monitors can also handle HD/SD-SDI input with an optional BKM-341HS HD/SD-SDI input adaptor. This optional feature allows this monitor to connect to HD/SD-SDI equipment for wide range of broadcast and post-production applications. Furthermore, these monitors offer an HD signal input capability via their HDMI and analog component interface, and also can accept DVI signals via the HDMI interface.\*1

\*1 Requires a DVI conversion cable.



The optional BKM-341HS HD/SD-SDI adaptor

## Control panel

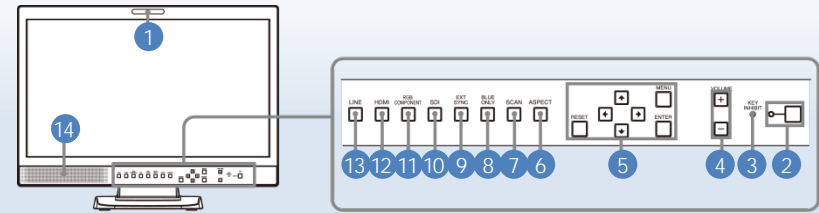

- 1 Tally lamp
- 2 standby switch and indicator
- 3 KEY INHIBIT indicator
- 4 VOLUME buttons
- 5 Menu operation buttons
- 6 ASPECT select button
- 7 SCAN select button
- 8 BLUE ONLY button
- 9 EXT SYNC (external sync) button
- 10 SDI button
- 11 RGB/COMPONENT button
- 12 HDMI button
- 13 LINE
- 14 Speaker

## Connector panel

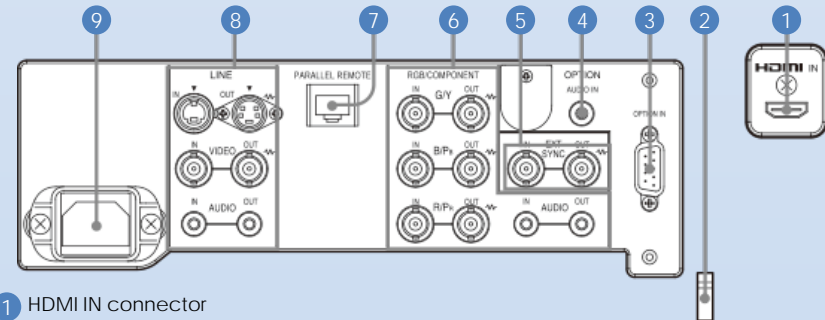

- 1 HDMI IN connector
- 2 HDMI cable holder
- 3 OPTION IN connector
- 4 OPTION AUDIO In (Phono jack)
- 5 EXT SYNC In/Out (external sync) (BNC)
- 6 RGB/COMPONENT (BNC), Audio (Phono jack)
- 7 PARALLEL REMOTE (modular connector)
- 8 LINE [composite (BNC), Y/C (Mini DIN 4-pin), Audio (Phono jack)]
- 9 AC In

# LMD-2110W

## LCD Monitors

### Input Signals / Input Adaptors

Video Signal Formats	Input signals				LMD-2110W			
	Total Line	Active Line	Aspect Ratio	Frame Rate <sup>*1</sup>	Composite T/C	RGB Component	HD-SDI SD-SDI	HDMI
					Standard		Option BKM-341HS	Standard
575/50i (PAL)	625	575	16:9 & 4:3	25	O	O	O	O
480/60i (NTSC) <sup>*1</sup>	525	483	16:9 & 4:3	30	O	O	O	O
576/50p	625	576	16:9 & 4:3	50	N.A.	O	N.A.	O
480/60p	525	483	16:9 & 4:3	60	N.A.	O	N.A.	O
1080/24PsF <sup>*1*3</sup>	1125	1080	16:9	24	N.A.	N.A.	O	N.A.
1080/25PsF <sup>*3</sup>	1125	1080	16:9	25	N.A.	N.A.	O	N.A.
1080/24p <sup>*1</sup>	1125	1080	16:9	24	N.A.	O <sup>*2</sup>	O	O
1080/25p	1125	1080	16:9	25	N.A.	O <sup>*2</sup>	O	O
1080/30p <sup>*1</sup>	1125	1080	16:9	30	N.A.	O <sup>*2</sup>	O	O
1080/50i	1125	1080	16:9	25	N.A.	O	O	O
1080/60 <sup>*1</sup>	1125	1080	16:9	30	N.A.	O	O	O
720/50p	750	720	16:9	50	N.A.	O <sup>*2</sup>	O	O
720/60p <sup>*1</sup>	750	720	16:9	60	N.A.	O	O	O
1080/50p	1125	1080	16:9	50	N.A.	N.A.	N.A.	N.A.
1080/60p <sup>*1</sup>	1125	1080	16:9	60	N.A.	N.A.	N.A.	N.A.

\*1 Compatible with 1/1.001.

\*2 For component input only.

\*3 Displayed as 1080/48i and 1080/50i on the screen, respectively.

### DVI Input Signals<sup>\*4</sup>

Resolution	Dot clock (MHz)	fH (kHz)	fV (Hz)
720 x 400 70Hz	28.322	31.469	70.087
800 x 600 56Hz	36.000	35.156	56.250
800 x 600 60Hz	40.000	37.879	60.317
1024 x 768 60Hz	65.000	48.363	60.004
1280 x 1024 60Hz	108.000	63.981	60.020

\*4 A DVI conversion cable is required. The sides of the displayed picture may be hidden depending on the input signal.

### Feature Comparison

Picture Performance	
Picture size (viewable area, measured diagonally)	21.5-inch
Resolution (pixels)	1920 x 1080
Input interface	
HD/SD-SDI (BNC)	Optional BKM-341HS (x1)
Composite (BNC)	(x1)
Y/C (Mini-DIN 4-pin)	(x1)
RGB / Component (BNC)	(x3)
DVI-D / HDMI	HDMI (x1) <sup>5</sup>
Audio (Phono jack)	(x3)
External sync (BNC)	(x1)
Remote control	
Parallel remote	Modular connector 8-pin (x1)
Features	
I/P mode selection	2 modes
Markers	Aspect, Center, Safety
Color temperature(D65, D93, and user)	High, Low, User
Gamma selection	5 modes
Scan mode (Normal (0%), Over (5%), Native)	0%, 5%, Full
Blue only	O
Tally	3 colors
EIA 19-inch rack-mounting	Optional MB-529
Wall mounting	100 x 100 mm
Desktop stand	Standard

<sup>5</sup> DVI signals can be input via the HDMI interface using a conversion cable.

# Professional Monitors Optional Accessories List

		OLED						LCD						
		Master Monitors			Picture Monitors							Basic Picture Monitors		
		BVM-X300	BVM-E251	BVM-E171	PVM-X550	PVM-A250	PVM-A170	LMD-A240	LMD-A220	LMD-A170	LMD-941W	LMD-B240	LMD-B170	LMD-2110W
BKM-17R	Monitor Control Unit	Yes*1*3	Yes	Yes	Yes*3	Yes*2	Yes*2	Yes*2	Yes*2	Yes*2	Yes*2	-	-	-
BKM-341HS	HD/SD SDI Input Adaptor	-	-	-	-	-	-	-	-	-	-	-	-	Yes
BKM-37H	Control Unit Attachment Kit with Tilt	-	Yes*4	-	-	-	-	-	-	-	-	-	-	-
BKM-38H	Control Unit Attachment Kit	-	Yes*4	-	-	-	-	-	-	-	-	-	-	-
BKM-39H	Control Unit Attachment kit	-	-	Yes*4	-	-	-	-	-	-	-	-	-	-
BKM-PL17	Protection Kit for the LMDA170	-	-	-	-	-	-	-	-	Yes	-	-	-	-
BKM-PP17	Protection Kit for the PVMA170	-	-	-	-	-	Yes	-	-	-	-	-	-	-
BKM-PP25	Protection Kit for the PVMA250	-	-	-	-	Yes	-	-	-	-	-	-	-	-
MB-L17	Mounting Bracket for LMDA-170	-	-	-	-	-	-	-	-	Yes	-	-	-	-
MB-P17	Mounting Bracket for PVMA-170	-	-	-	-	-	Yes	-	-	-	-	-	-	-
MB-L22	Mounting Bracket for LMDA-220	-	-	-	-	Yes	-	-	Yes	-	-	Yes*5	-	-
MB-529	Rack Mount Kit	-	-	-	-	-	-	-	-	-	-	-	-	Yes
MB-531	Rack Mount Kit	-	-	-	-	-	-	-	-	-	Yes	-	-	-
MB-532	Mounting Panel	-	-	-	-	-	-	-	-	-	Yes	-	-	-
MB-535	Rack Mount Kit	-	-	-	-	-	-	-	-	-	-	-	-	-
VF-510	Monitor ENG Kit	-	-	-	-	-	-	-	-	-	Yes	-	-	-
SU-561	Monitor Stand	-	-	-	-	Yes	Yes	Yes	Yes	Yes	-	-	-	-
SMF-17R20	Monitor Interface Cable	-	Yes	Yes	-	-	-	-	-	-	-	-	-	-

\*1 Supported from BVM-X300 with version 1.1.

\*2 Available functions of these monitors are limited.

\*3 New functions of BVM-X300 with version 2.0 or later and PVM-X550 can be assigned to the numeric keys from 1 to 9.

\*4 Product code suffix /3 or later.

\*5 Suffix/1 or later required.

# SONY



## Evolution of Excellence

Distributed by

MK20042V7SUZUMAR

©2018 Sony Imaging Products & Solutions Inc.

Reproduction in whole or in part without written permission is prohibited.  
Features, design, and specifications are subject to change without notice.

Screen images are simulated.

The values for mass and dimension are approximate.

"SONY" is a registered trademark of Sony Corporation.

"TRIMASTER", "TRIMASTER EL", "Memory Stick", "Memory Stick PRO", "Memory Stick Duo",  
"Memory Stick PRO Duo", and "Memory Stick Micro" are trademarks of Sony Corporation.

HDMI is a trademark of HDMI Licensing, LLC.

Adobe is a trademark of Adobe Systems Incorporated.

All other trademarks are the properties of their respective owners.

Please visit Sony's professional website or contact your Sony representative for specific models available in your region.